

RV1003
90 Degree Radius Bend
304/316

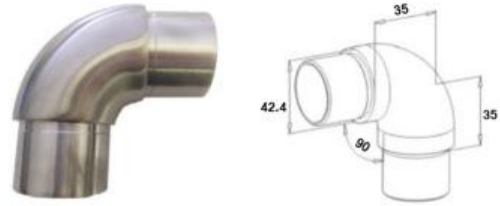

RV1008
90 Degree Radius Bend
304/316

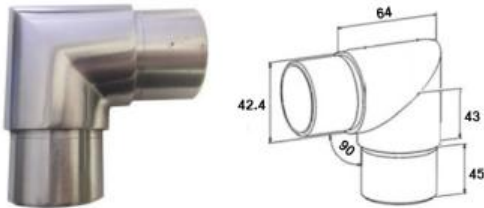

RV1005
90 Degree Sharp Bend
304/316

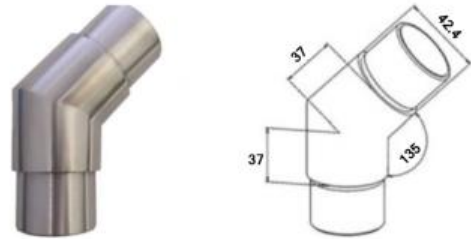

RV1007
135/45 Degree Tube Connector
304/316

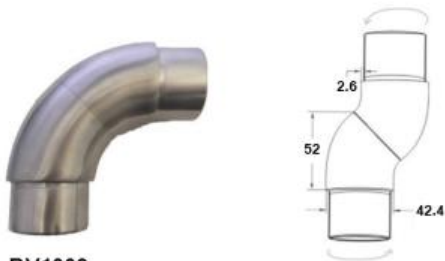

RV1009
Rotatable Bend
304/316

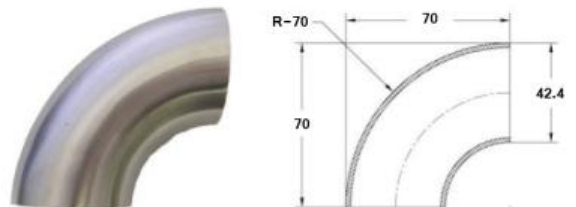

ROB42K
Weldable Elbow
304/316



EVB1009-42.4MM
3 Way Corner Connector
304/316

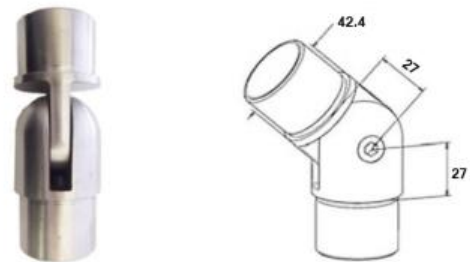

RV1004K-ADJUST-42
Adjustable Angle Changer
304/316

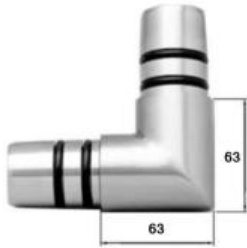

RV1005
90 Degree Sharp Bend
304



RV1004-35
30-40 Degree Angle Changer
304



RV1011
0-40 Degree Angle Changer
304



RV1005-42.4-Special
PRe-Drilled 90 Degree
Sharp Bend
304

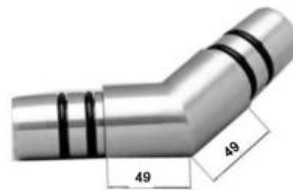

RV1007
45/135 Degree Offset Angle
304

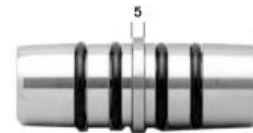

RV1001
Straight Connector
304



RA1006
Top Rail Insert
304



RA1010
Tube to Tube Connector
304



WND1001-42.4
Side Fix Bracket - 40mm Offset
304/316

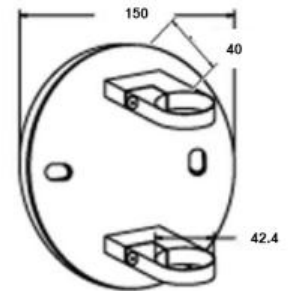

WND1008-42MM-304
Internal/External Corner, 40mm Offset
304/316

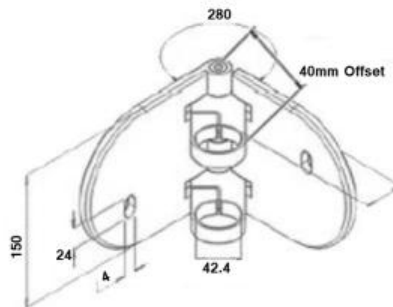

WND1001-42.4-Clip
Clip for Baluster Clamps
304/316

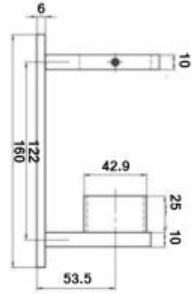

WND1012-42.4
Blank Side Fix, 27mm Offset
316

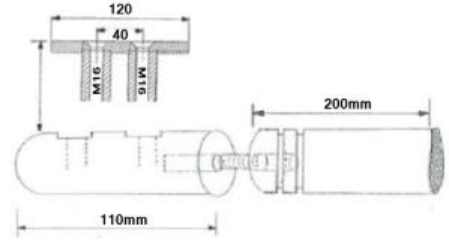

WND1005-42.4-200
Side Fix 30/50/80mm Offset
304/316



BDH1005-100x200
200mm Spigot and
100mm Plate
304/316



BDH1005-120x200
200mm Spigot and
120mm Plate
304/316



BDH1005-100x3-42.4
Smaller 68mm Spigot
x 100mm Plate
304/316



BDH1005-120x3-42.4
Smaller 68mm Spigot
x 120mm Plate
304/316



RHT1005-200-42.4
200mm Solid Spigot
304/316

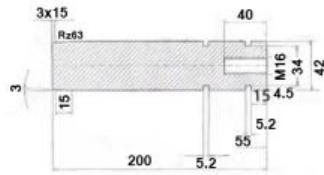

RHT1005-42.4K
68mm High Spigot x M16
304/316

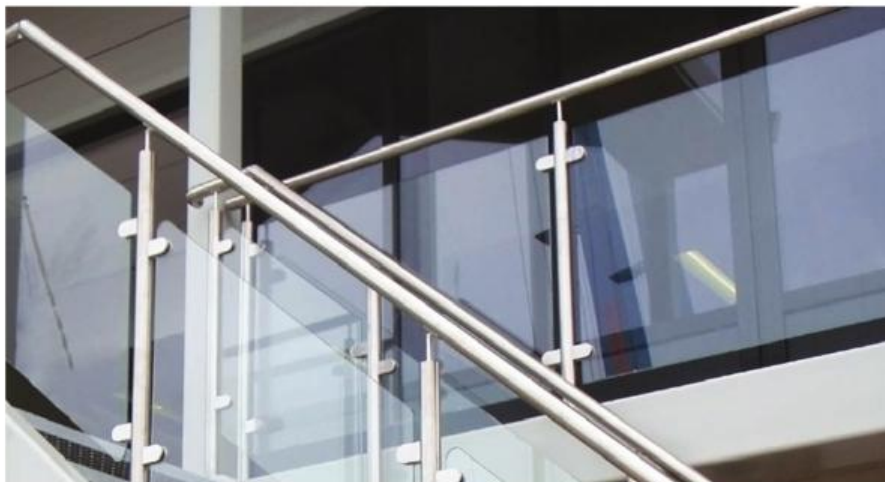
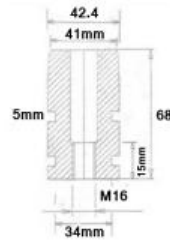

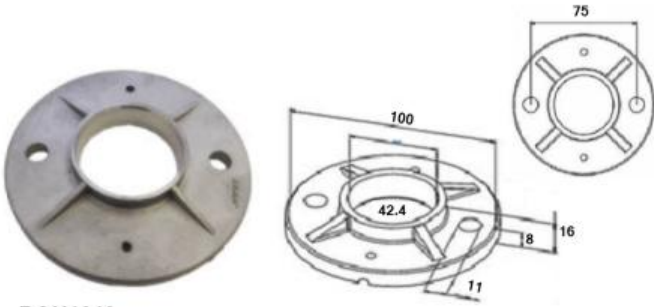

RON1012
Raw Weldable Plate
304/316

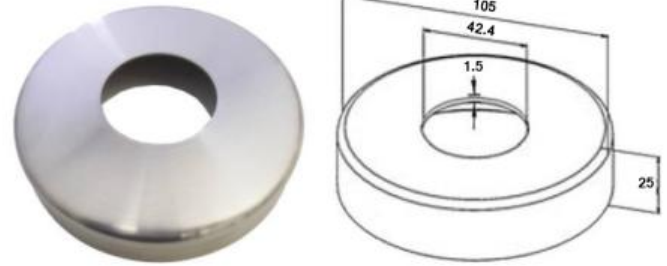

ROS1001
Cover Plate
304/316



RON1011
Raw Weldable Plate
304/316

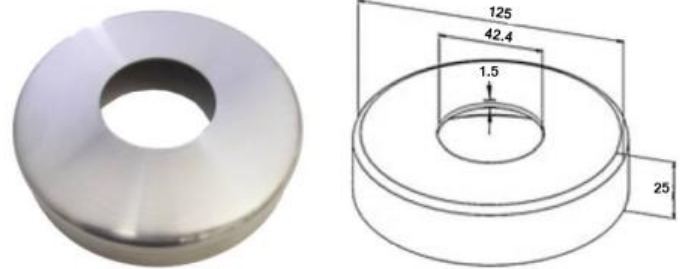

ROS1002
Cover Plate
304/316



RON1009-424-316
Plate 105mm x 3 Hole x 80mm c/line
316



ROS1005-42.4x316
Cover Plate 110 x 27mm High
316

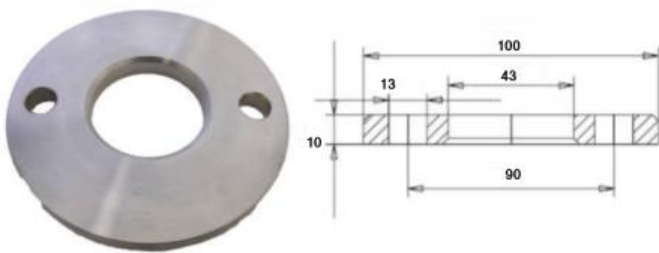

RON1010K-100-43
100mm x 43mm Large Hole
304



ROS1004-42.4-316
Flat Cover Plate
316



HH1060-M16-42.4
Top Insert
304

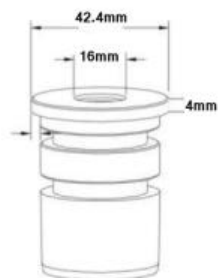

HH1060K-42.4
Flat Top Handrail Insert (M8)
304



HH1061K-42.4
Convex Top Handrail Insert (M8)
304



HH1062-42.4MM
Dome Head Handrail Insert (M8)
304



HH1040
Handrail Insert Drilled
15mm Rod and M8
304



HH1011-42.4mm
Handrail Insert 50 Degree
Offset
304



EK1014
Convex Drilled M8 End Cap
316



EK1006-316-42.4
Flat Post End Cap (M8)
304/316



HH1050-42.4
Ball with 43mm Hole
304



BDH1010-50
BDH1010-60-42.4
304/316



BDH1011-50
304



EK1002K-42.4
Flat End Cap
304/316

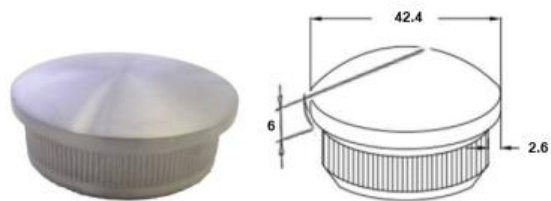

EK1010K-42.4
Convex End Cap
304/316

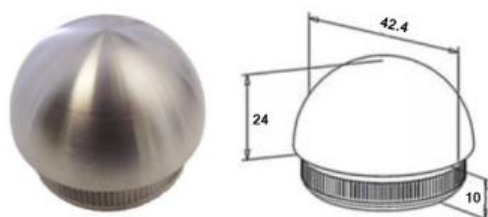

EK1018-42.4K
Dome End Cap
304/316



Wallplate-42.4
Wallplate x 3 Holes
304



Wallplate-Adj-42
Adjustable wallplate
304/316

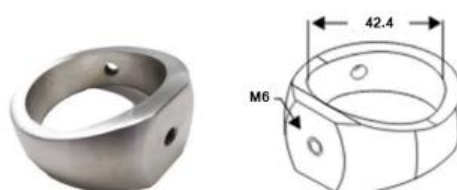

M6-Clip-42.4
Clip with M6 Tap
304/316



HH1001
Raking Handrail Support
304



GLS1001-304-42.4mm
Swivel Joint Handrail Support
304



HH1005
Straight Complete
304/316



HH1008
Adjustable Complete
304/316



HH1001K-H Straight Saddle 304/316
HH1001-H45 45 Degree Saddle 304/316
HH1001K-Z 90 Degree Saddle 304/316

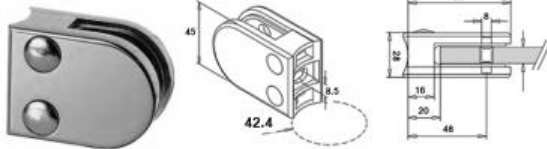

KLH10
D-Shape Glass Clamp

- KLH10R-42.4K-304 (304G Satin, 42.4mm 6-12mm Glass)
- KLH10R-42.4K (316G Satin, 42.4mm 6-12mm Glass)
- KLH10R/M-42.4 (304G Mirror, 42.4mm 6-12mm Glass)
- KLH10R-K-316/M/42.4 (316G Mirror, 42.4mm 6-12mm Glass)
- KLH10U-42.4K (Untreated, 42.4mm 6-12mm Glass)
- KLH10Z-42.4K (Zintec, 42.4mm 6-12mm Glass)

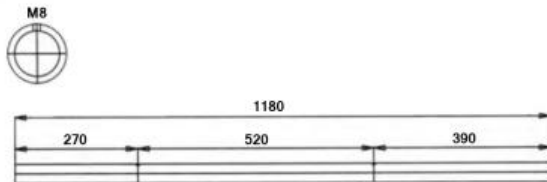

SP1001 - 1180mm High
End Post 2 x M8 pre-drilled holes at 520mm c/c

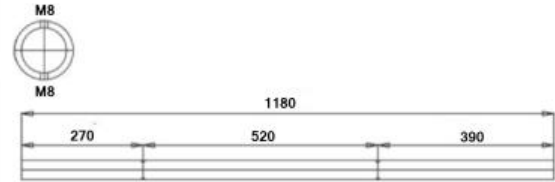

SP1002 - 1180mm High
Mid Post 4 x M8 pre-drilled holes by 180 degrees. Holes at 520mm c/c

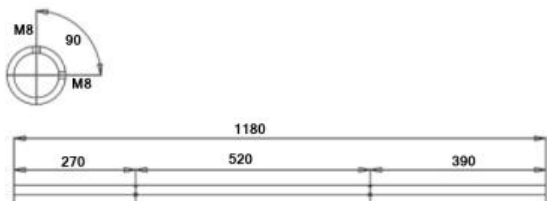

SP1003 - 1180mm High
90 Degree Corner Post 4 x M8 pre-drilled holes at 520mm c/c

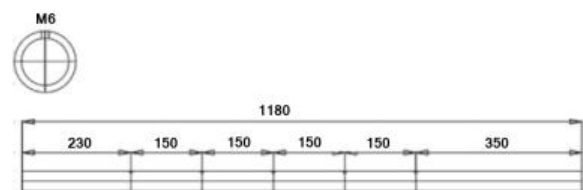

SP1004 - 1180mm High
5 x M6 pre-drilled set at 150mm c/c
Ideal for rod and wire fittings

System Posts are also Available in 304 & 316 Grades and Satin & Mirror Finishes