

CACHE-SCELLEMENTS - ROSETA EMBELLECEDOR BASE COLLARS - ABDECKROSETTEN AFDEKROZETTEN

FRANÇAIS : Platines et cache-scellements en fer forgé à chaud.

DEUTSCH : Warm geschmiedete Abdeckrosetten.

ENGLISH : Hot forged steel base collars.

NEDERLANDS : Warm gesmede afdekrozetten.

ESPAÑOL : Pletinas y embellecedores de hierro forjado en caliente.

55mm
2 1/8"



- 12 mm 1/2" CS 121
- 14 mm 9/16" CS 141
- 16 mm 5/8" CS 161
- 20x15 mm 13/16"x5/8" CS 241

55mm
2 1/8"



Ep. 6mm
T. 0,23"

CST 1

85mm
3 3/8"



- 20 mm 13/16" CS 201
- 25 mm 1" CS 251

85mm
3 3/8"



Ep. 8mm
T. 5/16"

CST 2

85mm
3 3/8"



Ø 8.5mm
Ø 0,33"

CST 5

50mm
2"



Ep. 6mm
T. 0,23"

- 12 mm 1/2" CS 120
- 14 mm 9/16" CS 140
- 16 mm 5/8" CS 160
- 16 x 8 mm 5/8" x 5/16" CS 168

70mm
2 3/4"



Ep. 6mm
T. 1/4"

- 20 mm 13/16" CS 200
- 20 x 15 mm 13/16" x 5/8" CS 240

80mm
3 1/8"



Ep. 6mm
T. 1/4"

- 25 mm 1" CS 250
- 30 mm 1 3/16" CS 300

85mm
3 1/8"



Ø 8.5mm
Ø 0,33"

- 20 mm 13/16" CS 205



CST 15

80mm
3 1/8"



- 20 mm 13/16" CS 203

80mm
3 1/8"



CST 3

63mm
2 1/2"

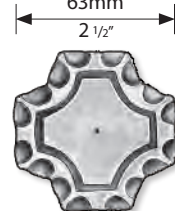

CST 7

75mm
3"

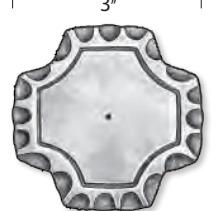

CST 8

FRANÇAIS : Cache-scellement en tôle ordinaire.

DEUTSCH : Abdeckrosetten aus Eisen.

ENGLISH : Base collars sheet steel.

NEDERLANDS : Afdekrozet gemaakt uit staal.

ESPAÑOL : Embellecedor de chapa.

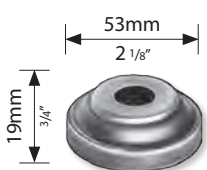

- 14 mm 9/16" CSR 4
- 16 mm 5/8" CSR 6

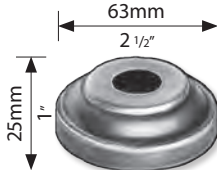

- 16 mm 5/8" CSR 7
- 18 mm 11/16" CSR 8

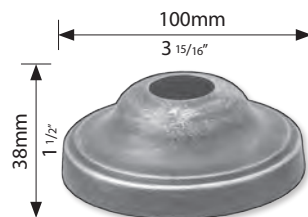

- 26,9 mm Sch.40 : 3/4" CSR 27
- 30 mm CSR 30
- 33,7 mm Sch.40 : 1" CSR 34

FRANÇAIS : Cache-scellements en fer forgé à chaud.

DEUTSCH : Warm geschmiedete Abdeckrosetten.

ENGLISH : Hot forged steel base collars.

NEDERLANDS : Warm gesmede afdekrozetten.

ESPAÑOL : Pletinas y embellecedores de hierro forjado en caliente.

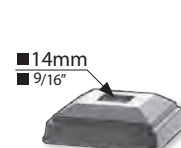

60mm
2 3/8"

CS 50

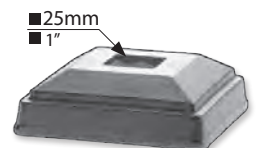

92mm
3 5/8"

CS 80



FRANÇAIS : Cache-scellements en fonte grise. Livrables bruts de fonderie (**NOUVEAU**) ou métallisés au zinc : "Z".

ENGLISH : Cast iron base collars, available as cast (**NEW**) or with **metallic zinc spray "Z"**.

ESPAÑOL : Embellecedores en fundición gris, se sirven en bruto de fundición (**NUEVO**) ó **mezalizados en zinc "Z"**.

DEUTSCH : Grauguß Abdeckrossetten Lieferbar roh (**NEUE**) oder **Zinkspritz metallisiert "Z"**.

NEDERLANDS : Gietijzeren afdekrosetten, leverbaar als omschreven (**NIEUW**) of **gemetaliseerd "Z"**.

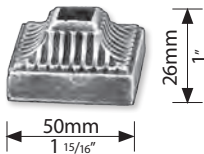

Zingué - Zing Plated
Verzinkt - Zincado

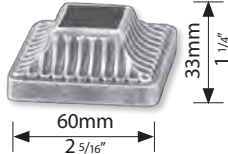

Zingué - Zing Plated
Verzinkt - Zincado



Zingué - Zing Plated
Verzinkt - Zincado



Zingué - Zing Plated
Verzinkt - Zincado

14 mm 9/16"	FOC 52	FOC 52Z
16 x 8 mm 5/8 x 9/16"	FOC 53	FOC 53Z

16 mm 5/8"	FOC 62	FOC 62Z
---------------	---------------	----------------

20 mm 13/16"	FOC 82	FOC 82Z
25 mm 1"	FOC 83	FOC 83Z

30 mm 1 3/16"	FOC 85	FOC 85Z
35 mm 1 7/16"	FOC 84	FOC 84Z

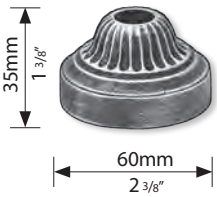

Zingué - Zing Plated
Verzinkt - Zincado

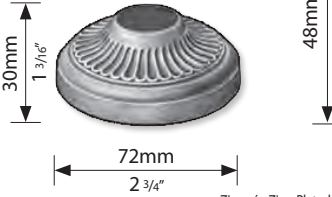

Zingué - Zing Plated
Verzinkt - Zincado

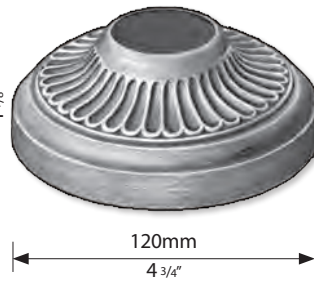

Zingué - Zing Plated
Verzinkt - Zincado

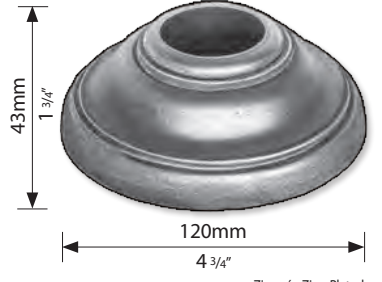

Zingué - Zing Plated
Verzinkt - Zincado

16 mm 5/8"	FOC 16	FOC 16Z
---------------	---------------	----------------

18 mm 1 1/16"	FOC 71	FOC 71Z
25 mm 1"	FOC 72	FOC 72Z

40 mm 1 5/8"	FOC 124	FOC 124Z
-----------------	----------------	-----------------

40 mm 1 5/8"	Sch.40	FOC 224	FOC 224Z
42,4 mm 1 11/16"	Sch.40 1 1/4"	FOC 225	FOC 225Z

Platines de fixation en fer

Eisen Bodenrosetten

Steel anchor bases

Montageringen voor spijlen en balusters

Platina de fijacion en hierro.

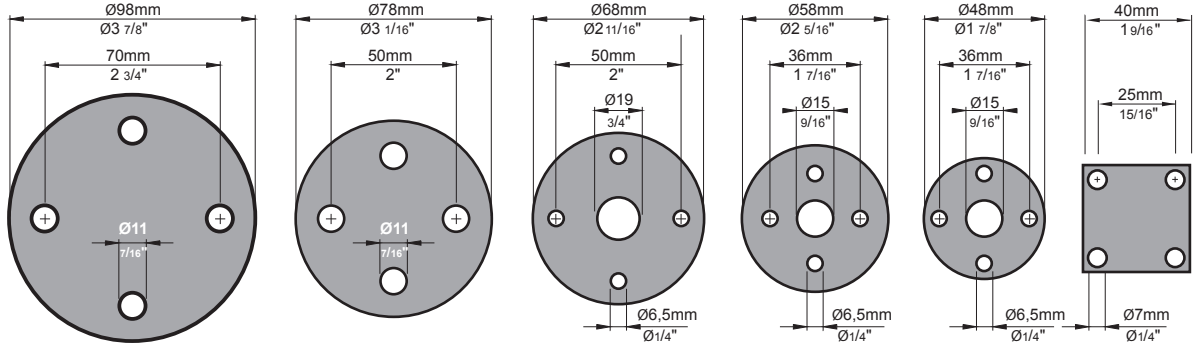

RF 100	RF 80	RF 70	RF 60	RF 50	RF 40
8 mm 5/16"	8 mm 5/16"	6 mm 1/4"	6 mm 1/4"	6 mm 1/4"	5 mm 3/16"

FRANÇAIS : Vis écrous à tête forgée décorative en pointe de diamant.

ENGLISH : Forged nail-headed screws and nuts. Decorative screws are not suitable for fastening the RF anchor bases. The maximum torque is 18N.m.

Ne pas utiliser pour fixer des RF. Couple maximum limité à 18N.m.

NEDERLANDS : Warm gesmede sierkopschroeven. Sierkopschroeven, niet geschikt voor bevestiging van bevestigingsrosetten RF. Maximum draaimoment is 18N.m.

DEUTSCH : Zierkopfschrauben, nicht geeignet zur Befestigung der Bodenrosetten RF. Maximales Drehmoment beschränkt auf 18N.m.

ESPAÑOL : Tornillo y tuerca con cabeza forjada con punta de diamante. Tornillo decorativo, no utilizar para fijar las pletinas RF. Par máximo limitado a 18 N.m.

FRANÇAIS : Vis de sécurité en acier trempé à sens unique : Dévissage impossible.

DEUTSCH : Einweg-Sicherheits-Schraube aus gehärtetem Stahl. Die Schrauben können nicht mehr herausgedreht werden.

ENGLISH : One way security screw, heat threaded (5/16" x 3"). Unscrewing will be impossible.

NEDERLANDS : Veiligheidsschroef uit gehard staal. Deze kan na montage niet meer losgedraaid worden.

ESPAÑOL : Tornillo unidireccional de seguridad de acero templado. Una vez atornillado ya no puede destornillarse.

FRANÇAIS : Vis de sécurité indéserrable, par rupture de la tête hexagonale.

DEUTSCH : Abscheer-Sicherheits-Schraube. Sechskant-Kopf reißt bei einem bestimmten Druckpunkt ab.

ENGLISH : Security lock screw, by breaking off the hexagonal head.

NEDERLANDS : Veiligheidsbout met zeskant kop die na montage is afgedraaid. Daarna is de bout niet meer te demonteren.

ESPAÑOL : Tornillo de seguridad indestornillable si se rompe la cabeza hexagonal.



Par 10 - Per 10

6 mm 1/4"	L: 36 mm L: 1 7/16"	A: 14 mm A: 9/16"	VB 640
8 mm 5/16"	L: 56 mm L: 2 3/16"	A: 16 mm A: 5/8"	VB 860



Par 10 - Per 10

M6	VM 670	B: 14 mm B: 9/16"
M8	VM 870	B: 16 mm B: 5/8"



Par 10 - Per 10

M6	VE 6	C: 14 mm C: 9/16"
M8	VE 8	C: 16 mm C: 5/8"

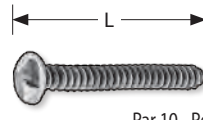

Par 10 - Per 10

8 mm 5/16"	L: 50 mm L: 1 9/16"	VSU 50
8 mm 5/16"	L: 70 mm L: 3"	VSU 70

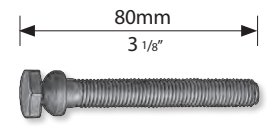

Par 10 - Per 10

M10	VH 108
-----	---------------