

MANCHONS - ZIERHÜLSEN - SLEEVES - SIERHULZEN - MACOLLAS

FRANÇAIS : Manchons décoratifs en fonte grise équipés d'une vis de blocage. **INAPTE À LA GALVANISATION.**

DEUTSCH : Zierhülsen aus Grauguß. Ausgerüstet mit einer Blockierschraube. **UNGEEIGNET FÜR FEUERVERZINKUNG.**

ENGLISH : Decorative cast iron sleeves. Supplied with a set screw. **NOT SUITABLE FOR HOT DIP GALVANIZING.**

NEDERLANDS : Gietijzeren sierhulzen. Voorzien van een blokkeerschroefje om de sierhuls vast te zetten. **NIET VERZINKBAAR.**

ESPAÑOL : Macollas decorativas en fundición gris, equipados con tornillo de fijación. **NO APTAS PARA LA GALVANIZACIÓN.**

FRANÇAIS : Manchons décoratifs, en acier, tournés. Equipés d'une vis de blocage. **GALVANISABLES.**

DEUTSCH : Zierhülsen aus Stahl, abgedreht. Ausgerüstet mit einer Blockierschraube. **FEUERVERZINKBAR.**

ENGLISH : Decorative steel sleeves. Supplied with set screw. **SUITABLE FOR HOT DIP GALVANIZING.**

NEDERLANDS : Stalen sierhulzen, gedraaid. Voorzien van een blokkeerschroefje om de sierhuls vast te zetten. Materiaal St. 37, **VERZINKBAAR.**

ESPAÑOL : Macollas decorativas en acero, torneadas. Equipadas con tornillo de fijación. **GALVANIZABLES.**

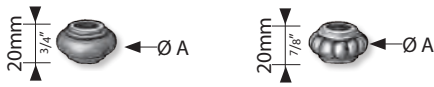

● 14 mm 9/16"	FOM 114	ØA : 32mm ØA : 1 1/4"	FOM 214
● 16 mm 5/8"	FOM 116	ØA : 32mm ØA : 1 1/4"	FOM 216
● 18 mm 11/16"	FOM 118	ØA : 35mm ØA : 1 3/8"	FOM 218

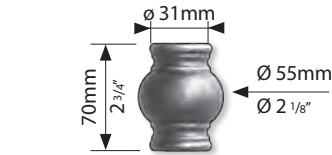

FOM 721	● 30 mm 1 3/16"	EG 741
----------------	--------------------	---------------

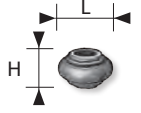

● 14 mm 9/16"	L: 33 mm L: 1 5/16"	H: 24 mm H: 15/16"	EG 114
● 16 mm 5/8"	L: 37 mm L: 1 7/16"	H: 27 mm H: 1 1/16"	EG 116
● 18 mm 11/16"	L: 41 mm L: 1 5/8"	H: 30 mm H: 1 3/16"	EG 118

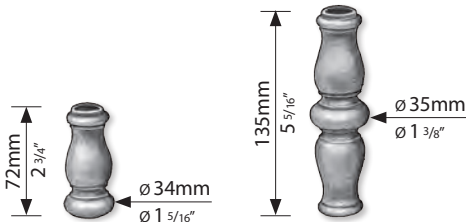

● 14 mm 9/16"	FOM 514	FOM 714
● 16 mm 5/8"	FOM 516	FOM 716

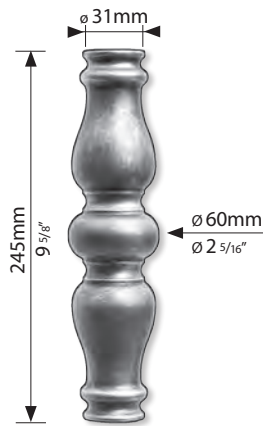

-	● 30 mm 1 3/16"	EG 743
---	--------------------	---------------

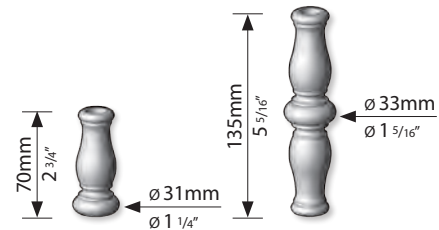

● 14 mm 9/16"	EG 514	EG 714
------------------	---------------	---------------

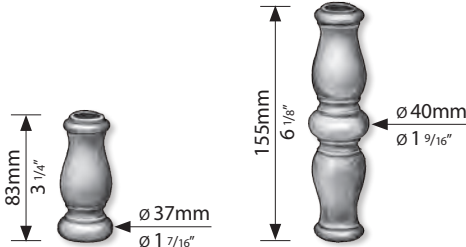

● 18 mm 11/16"	FOM 518	FOM 718
-------------------	----------------	----------------

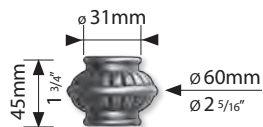

-	● 30 mm 1 3/16"	EG 831
---	--------------------	---------------

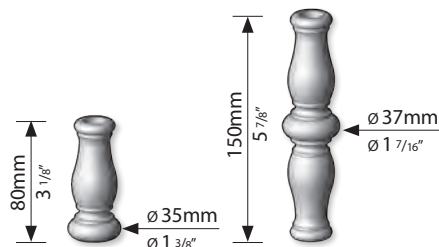

● 16 mm 5/8"	EG 516	EG 716
-----------------	---------------	---------------

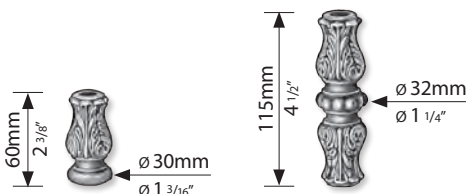

● 14 mm 9/16"	FOM 414	FOM 814
● 16 mm 5/8"	FOM 416	FOM 816

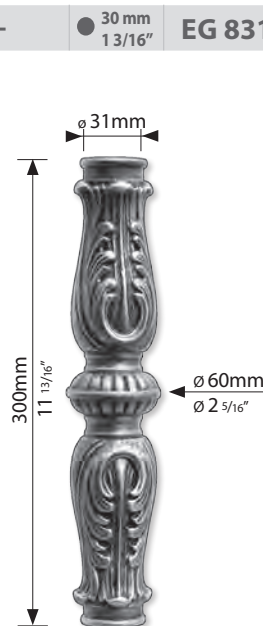

-	● 30 mm 1 3/16"	EG 833
---	--------------------	---------------

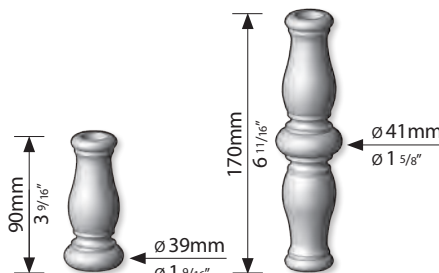

● 16 mm 11/16"	EG 518	EG 718
-------------------	---------------	---------------

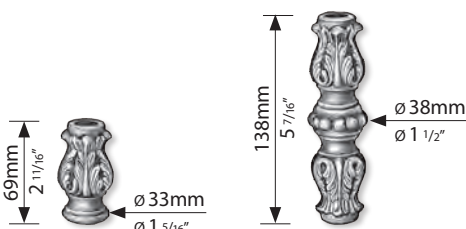

● 18 mm 11/16"	FOM 418	FOM 818
-------------------	----------------	----------------

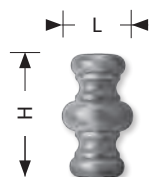

● 14 mm 9/16"	L: 36 mm L: 1 7/16"	H: 65 mm H: 2 9/16"	EG 614
● 16 mm 5/8"	L: 38 mm L: 1 1/2"	H: 69 mm H: 2 11/16"	EG 616
● 18 mm 11/16"	L: 43 mm L: 1 11/16"	H: 74 mm H: 2 15/16"	EG 618

MANCHONS EN ACIER - ZIERHÜLSEN AUS STAHL - STEEL SLEEVES STALEN SIERHULZEN - MACOLLAS DE ACERO

FRANÇAIS : Manchons décoratifs pour fers carrés en acier moulé, **GALVANISABLES.**
Equipés d'une vis de blocage.

DEUTSCH : Zierhülsen für Vierkanteisen aus Schmiedeguß, **FEUERVERZINKBAR.**
Ausgerüstet mit einer Blockierschraube.

ENGLISH : Decorative steel sleeves for square bars, **SUITABLE FOR GALVANIZING.**
Supplied with set screw.

NEDERLANDS : Sierhulzen voor vierkante balusters, uit smeedbaar gietijzer,
VERZINKBAAR en voorzien van blokkeerschroefje.

ESPAÑOL : Macollas decorativas para cuadradillo de hierro ; en acero moldeado,
GALVANIZABLE. Equipado con tornillo de fijación.

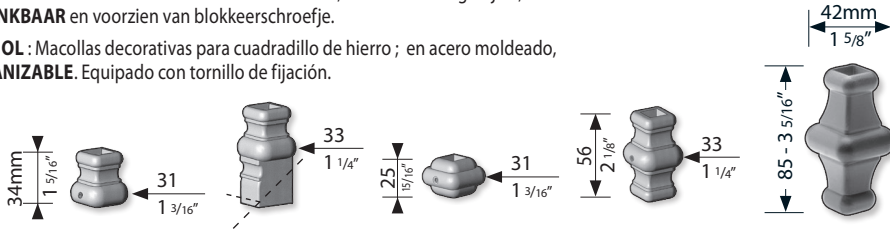

12 mm 1/2"	EGK 31	-	EGK 12	EGK 51	-
14 mm 9/16"	EGK 32	EGK 33	EGK 14	EGK 52	EGK 82

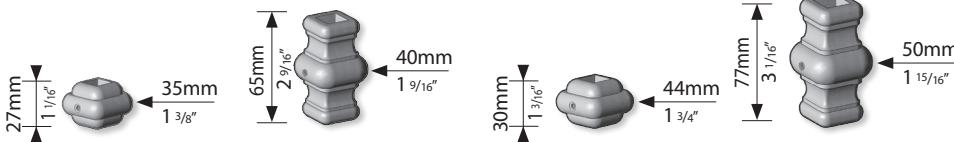

16 mm 5/8"	EGK 16	EGK 66	20 mm 3/4"	EGK 20	EGK 80
---------------	---------------	---------------	---------------	---------------	---------------

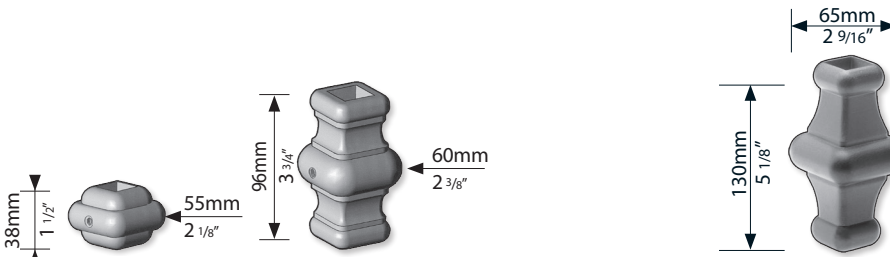

25 mm 1"	EGK 25	EGK 100	EGK 125
-------------	---------------	----------------	----------------

FRANÇAIS : **ESK202:** Partie centrale de balustre en fer forgé à chaud, à souder sur fer carré de 12 à 16 mm. Voir exemple ci-dessous.

DEUTSCH : **ESK202:** Einschweisstück aus Stahl, warm geschmiedet. Für Vierkant 12-16 mm. Siehe unten Anwendungsbeispiel.

ENGLISH : **ESK202:** Baluster center made of hot forged steel ; to weld onto 12 to 16 mm (1/2" to 5/8") square bars. See illustration below.

NEDERLANDS : **ESK202:** Middenstuk voor baluster vervaardigt uit warm gesmeed ijzer, om tussen spijlen van vierkant 12 of 16 mm te lassen. Zie onderstaand voorbeeld.

ESPAÑOL : **ESK202:** Elemento central de balustre en hierro forjado en caliente para soldar a barra cuadrada de 12 a 16 mm. Ver ejemplo más abajo.

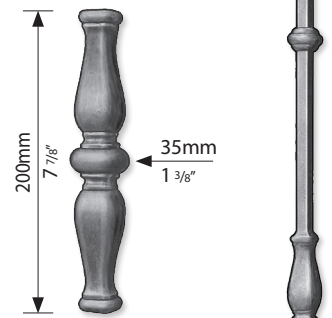

ESK 202

Exemple d'utilisation
Anwendungsbeispiel
For illustration purpose only
Voorbeeld voor toepassing
Ejemplo de empleo

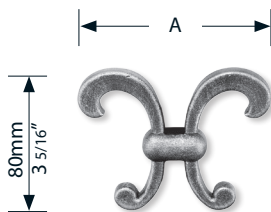

NEW

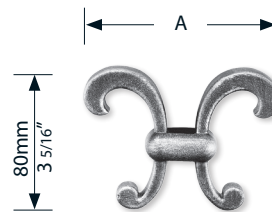

NEW

14 mm 9/16"	A = 101 mm A = 4"	D 82 R
16 mm 5/8"	A = 103 mm A = 4 1/16"	D 83 R

12 mm 1/2"	A = 104 mm A = 4 1/8"	D 81 K
14 mm 9/16"	A = 106 mm A = 4 3/16"	D 82 K

Manchons en acier moulé.
Zierhülsen aus Schmiedeguß.
Decorative steel sleeves.
Sierhulzen van gietstaal.
Macollas en acero moldeado.

Boules plates tournées, avec trou 5,5 mm.
Gedrehte Flachkugeln, mit 5,5 mm Loch.
Turned flattened balls, with 5.5 (0.21") hole.
Gedraaide halfronde ringen, met gat Ø 5,5 mm.
Bolas planas torneadas.

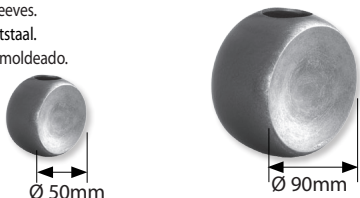

12 mm 1/2"	EG 551	30 mm 1 3/16"	EG 553
---------------	---------------	------------------	---------------

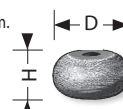

H: 13 mm H: 1/2"	D: 21 mm D: 1 3/16"	OL 13
H: 15 mm H: 9/16"	D: 27 mm D: 1 1/16"	OL 15

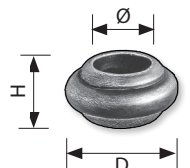

Ø: 14,5 mm Ø: 9/16"	H: 23 mm H: 7/8"	D: 34 mm D: 1 5/16"	EG 14
Ø: 17 mm Ø: 11/16"	H: 23 mm H: 7/8"	D: 38 mm D: 1 1/2"	EG 16
Ø: 18,5 mm Ø: 3/4"	H: 23 mm H: 7/8"	D: 40 mm D: 1 9/16"	EG 18
Ø: 20,5 mm Ø: 13/16"	H: 23 mm H: 7/8"	D: 41 mm D: 1 5/8"	EG 20
Ø: 31 mm Ø: 1 3/16"	H: 35 mm H: 1 3/8"	D: 63 mm D: 2 1/2"	EG 30