

*Test reports are available upon request

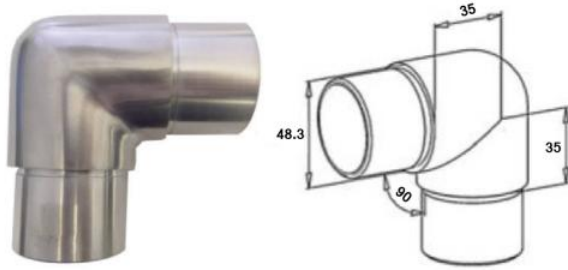

48-RV1003
90 Degree Short Radius Bend
 304/316

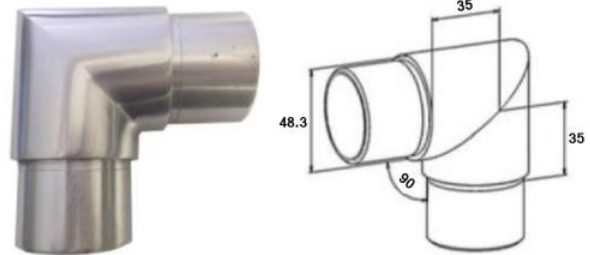

48-RV1005
90 Degree Sharp Bend
 304/316

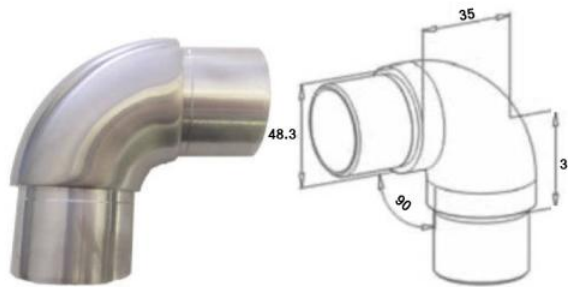

48-RV1008
90 Degree Radius Bend
 304/316

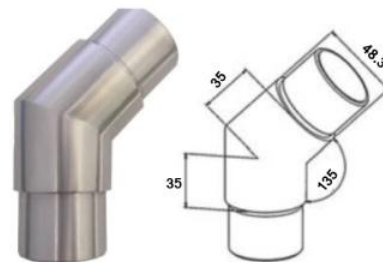

48-RV1007
135/45 Degree Connector
 304/316

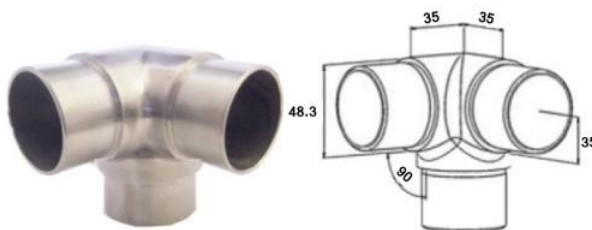

48-EVB1009
3 Way Corner Connector
 304/316

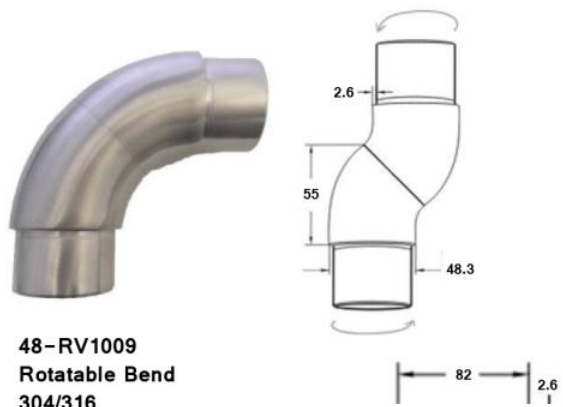

48-RV1009
Rotatable Bend
 304/316



48-RV1001
Tube Connector
 304/316



48-MVB1003
3 Way Connector
 304/316

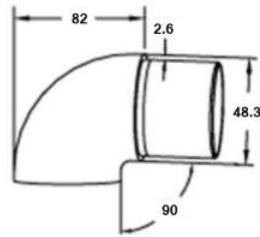

48-RV1018-FLAT
Flat End Scroll
304/316

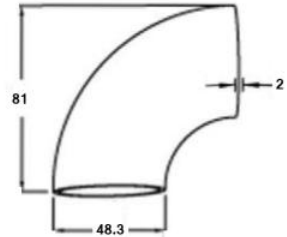
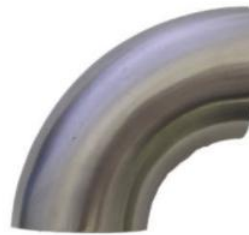

48-ROB
Weldable Elbow x 2mm Wall
304/316

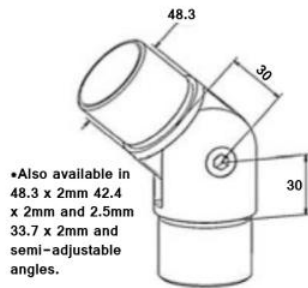

48-RV1004-ADJ
Adjustable Angle Changer
304/316

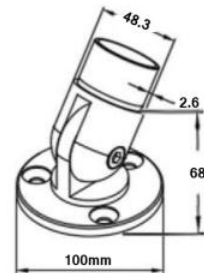

WALLPLATE-ADJ-48.3MM
Adjustable Wall Plate
304/316

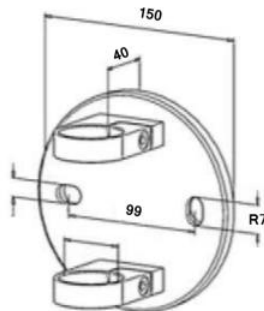

48-WND1001
Side Fix Baluster Clamp x 40mm Offset
304/316

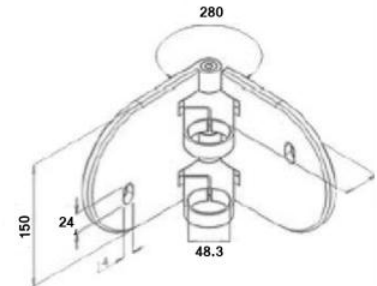

48-WND1008
Internal/External Corner x 40mm Offset
304/316

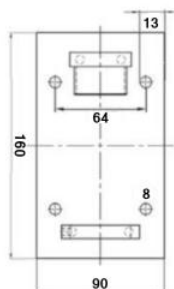

WND1012-48.3-316
Blank Side Fix x 21mm Offset
316

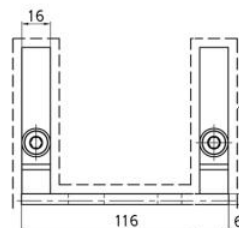

48-Wall-Bracket-316
Small Blank Side Fix
316 Satin



90mm
Hole Centres

WND1005-48-200
Side Fix Bracket 30/50/80mm Offset
304/316

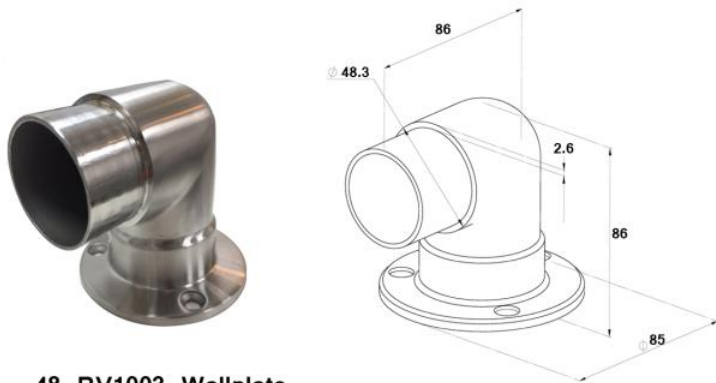

48-RV1003-Wallplate
316 Grade - Satin Finish
Wallplate and 90 Degree Bend

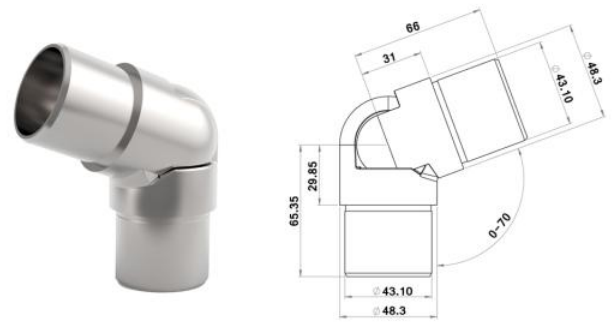

48-RV1004-Smooth
316 Grade - Satin Finish
Smooth Adjustable Bend



BDH1005 (100mm + 120mm)
Available 68mm + 200mm Spigot
304/316 Grade Satin



RHT1005-48.3-68
68mm High Spigot x M16
304/316



48-RA1004
Smooth Adjustable Connector
316

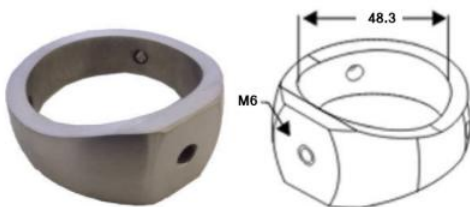

M6-CLIP-48
Clip with M6 Tap
304/316

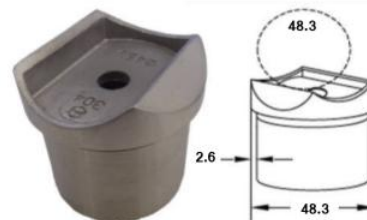

48-RA1006
Adaptor
304/316

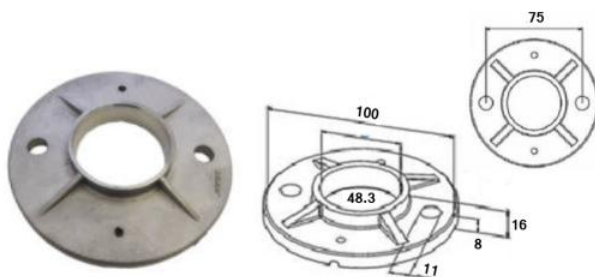

48-RON1012
Raw Weldable Plate
304/316



48-ROS1001
Cover Plate
304/316

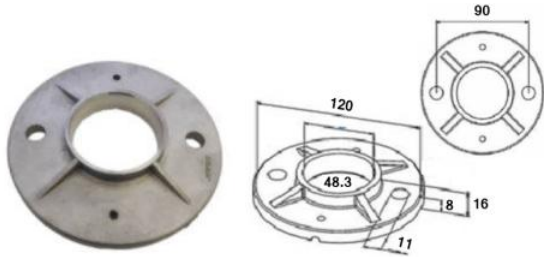

48-RON1011
Raw Weldable Plate
304/316

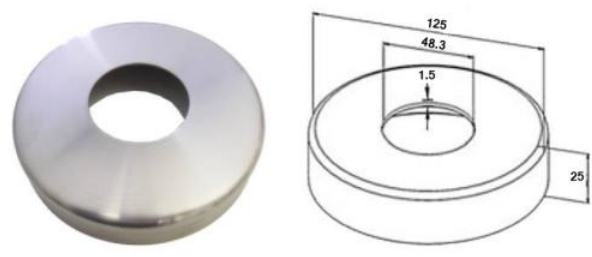

48-ROS1002
Cover Plate
304/316

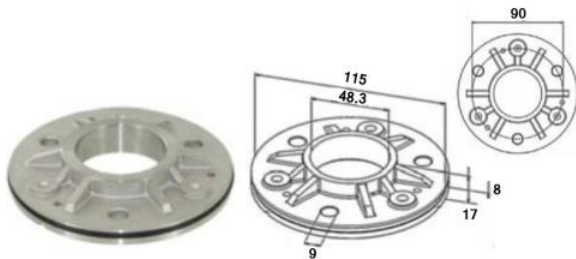

48-RON1009-316
Raw Weldable Plate 115mm x 3 Hole x 90c/line
316

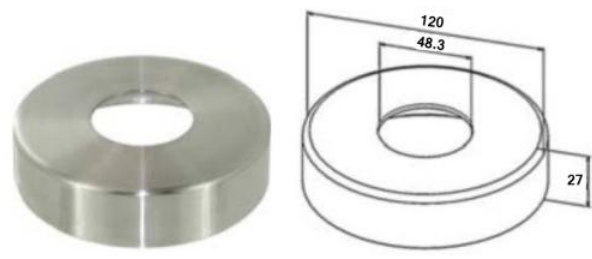

ROS1005-48.3-316
Cover Plate
316

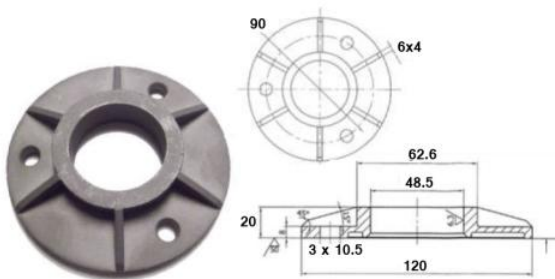

48-RON1016
Raw Weldable Plate 120mm x 3 Hole x 90 c/line
304/316

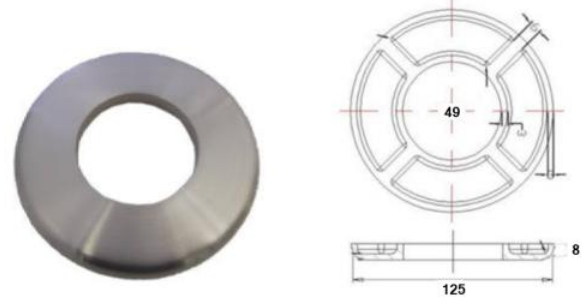

ROS1004-48
Low Cover Plate for Diamond Holes
316

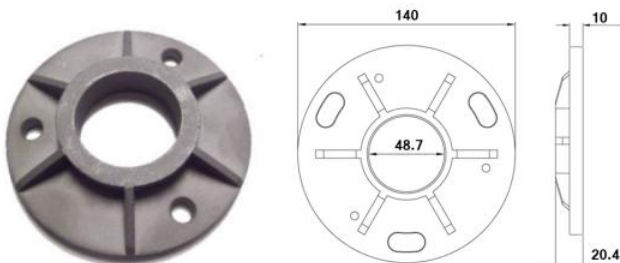

48-RON1017
Raw Weldable Plate 140mm x 3 Hole
316

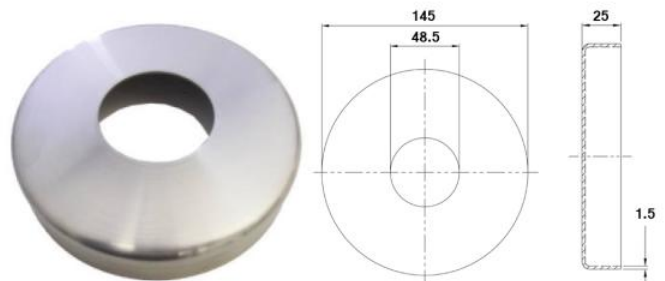

48-ROS1003-145
145mm Cover Plate
316

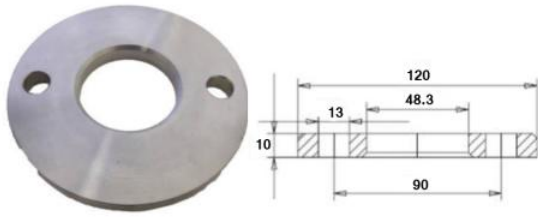

RON1010-120-483
Round Plate with M13 Holes
304/316

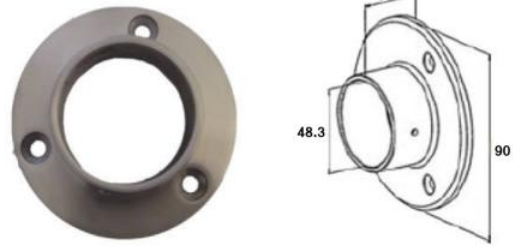

48-WALLPLATE
304/316

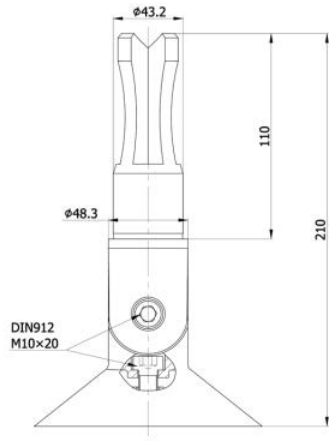

48-BASE-PLATE-ADJ
48.3 x 2.5mm Wall Adjustable Base Plate
316 Satin Finish

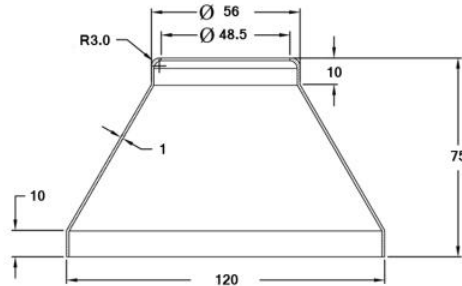
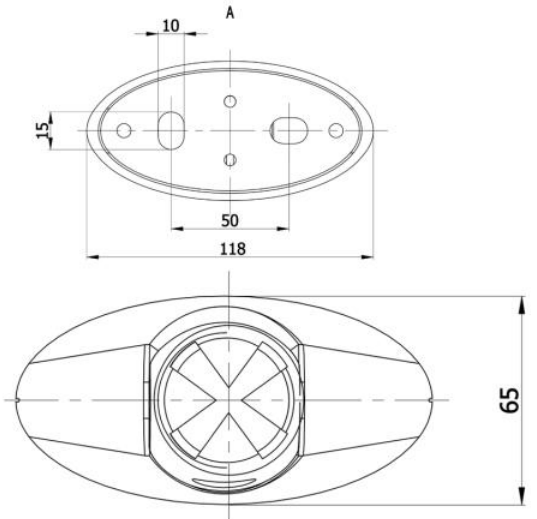

ROS1100B-48.3
Asphalt Cover Plate 120 x 75mm x 48.3mm Tube
316G Satin/Mirror

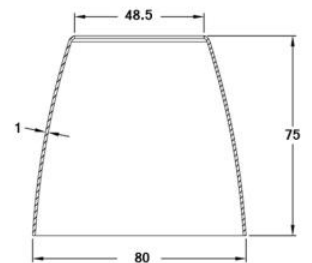

ROS110A-48.3
Asphalt Cover Plate 80 x 75 x 1mm x 48.3mm Tube
316G Satin/Mirror

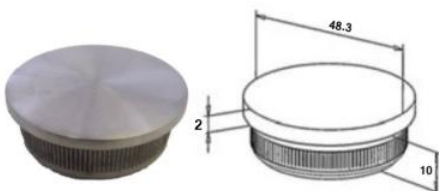

48-EK1002
Flat End Cap
304/316

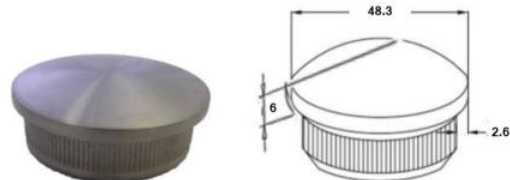

48-EK1010
Convex End Cap
304/316

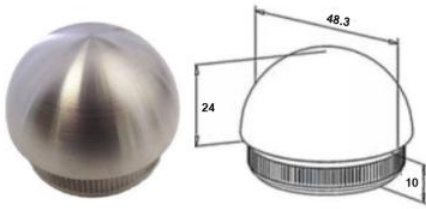

48-EK1018
Dome End Cap
304/316



48-EK1006
Flat End Cap with M8 Hole
304/316



48-EK1014
Convex End Cap with M8 Hole
304/316



48-HH1005-ADJ
48.3 x 2.5mm Wall
316 Satin Finish



48-HH1005-ADJ-90
48.3 x 2.5mm Wall
90 Degree Saddle
316 Satin Finish



48-HH1008-ADJ
48.3 x 2.5mm Wall
316 Satin Finish

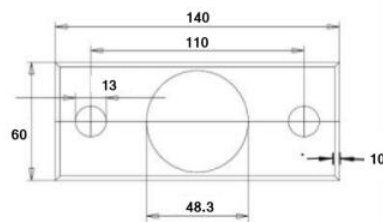

RON1014K-48.3-316
Weldable Plate - Satin Polished x 320
316

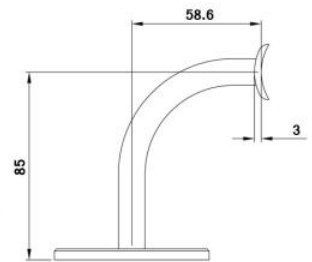

WS172 - 85mm Offset - 316 (Satin)
48.3mm Saddle, 85mm Offset
316 Satin

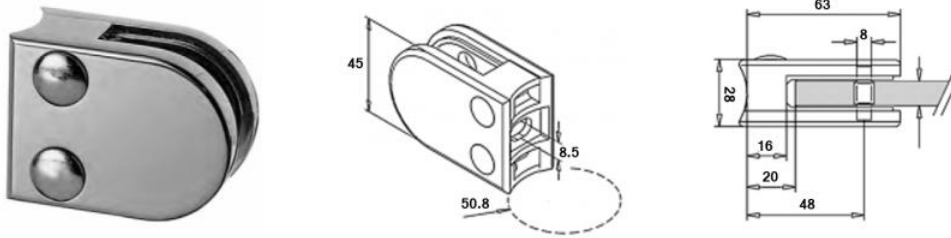

KLH10R-K-304 (304G Satin, 48.3mm 6-12mm Glass)
 KLH10R-48.3K (316G Satin, 48.3mm 6-12mm Glass)
 KLH10R/M-48.3 (304G Mirror, 48.3mm 6-12mm Glass)
 KLH10R-K-316M (316G Mirror, 48.3mm 6-12mm Glass)
 KLH10U-48.3K (Untreated, 48.3mm 6-12mm Glass)
 KLH10Z-48.3K (Zintec, 48.3mm 6-12mm Glass)

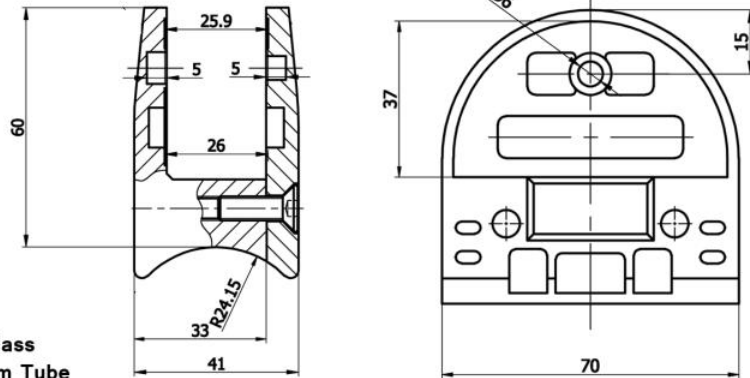
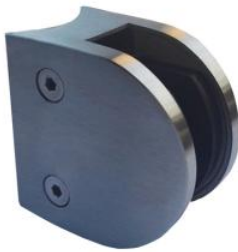

KLH21.5MM-R-316
 Suitable for 15, 17.52, 19 and 21.52mm Glass
 316 Grade - Satin / Mirror - 48.3 / 50.8mm Tube
 (Also available with a 'Flat Back')

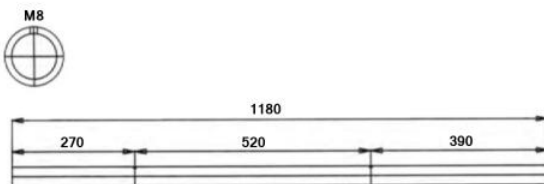

SP1001 - 1180mm High
 End Post 2 x M8 pre-drilled holes at 520mm c/c

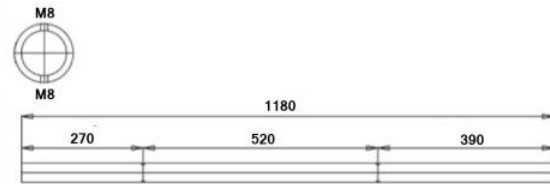

SP1002 - 1180mm High
 Mid Post 4 x M8 pre-drilled holes by 180 degrees. Holes at 520mm c/c

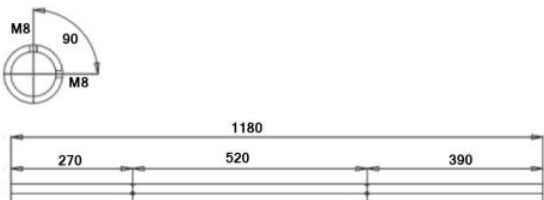

SP1003 - 1180mm High
 90 Degree Corner Post 4 x M8 pre-drilled holes at 520mm c/c

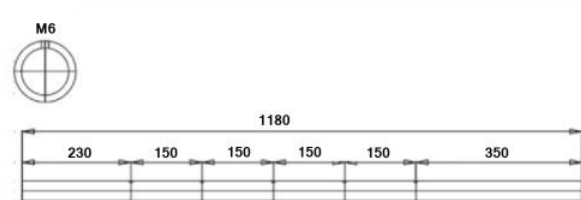

SP1004 - 1180mm High
 5 x M6 pre-drilled set at 150mm c/c
 Ideal for rod and wire fittings

System Posts are also Available in 304 & 316 Grades and Satin & Mirror Finishes