

# CARBONE

**FRANÇAIS :** La forte tendance à l'individualisation que l'on observe en aménagement intérieur, nous a incité à développer cette collection. Les barreaux sont réalisés manuellement en FIBRE DE CARBONE. Ils sont montés au choix avec des embouts en acier, carrés (K), ronds (R) ou rond inox (W). L'accent est mis sur les couleurs ce qui ajoute de la flexibilité au concept. Usage exclusive en intérieur.

**ENGLISH :** The strong trend towards individualization that we observe in interior design, prompted us to develop this collection. Balusters are hand made in CARBON FIBER. They are assembled with endpieces in steel, square (K) round (R) or round stainless steel endpieces (W). The focus is on the colors, which adds flexibility to the concept. These items are for interior use only.

**DEUTSCH :** Der starke Trend zur Individualisierung, den wir bei der Inneneinrichtung beobachten, veranlasste uns, diese Kollektion zu entwickeln. Die Baluster sind handgefertigt aus KARBONFASER. Sie werden mit Endstücken aus Stahl, Viereck (K) oder Rund (R) oder runden Edelstahlendstücken (W) montiert. Der Fokus liegt auf den Farben, die dem Konzept Flexibilität verleihen. Diese Artikel sind nur für den Innenbereich bestimmt.

**NEDERLANDS :** De sterke trend naar individualisering die we waarnemen bij het interieurontwerp, heeft ons ertoe aangezet deze collectie te ontwikkelen. Balusters worden met de hand gemaakt in CARBON FIBER. Ze worden geassembleerd met eindplaten in staal, vierkant (K) of rond (R) of rond roestvrijstalen eindstukken (W). De focus ligt op de kleuren, wat flexibiliteit aan het concept toevoegt. Deze artikelen zijn alleen voor gebruik binnenshuis.

**ESPAÑOL :** La fuerte tendencia hacia la individualización que observamos en el diseño de interiores, nos llevó a desarrollar esta colección. Los balaustres están hechos a mano en FIBRA DE CARBONO. Se ensamblan con terminales en acero, cuadrado (K) o redondo (R) o redondo terminales de acero inoxidable (W). La atención se centra en los colores, lo que agrega flexibilidad al concepto. Estos artículos son solo para uso interior.

**RUSSE :** Сильная тенденция к индивидуализации, которую мы наблюдаем в дизайне интерьера, побудила нас развивать эту коллекцию. Балясины сделаны вручную из УГЛЕРОДНОГО ВОЛОКНА. Они собираются из концевых наконечников из стали, квадратного (K) или круглого (R) и изогнутых наконечников из нержавеющей стали (W). Основное внимание уделяется цветам, что добавляет концепции гибкости. Эти предметы предназначены только для внутреннего использования.

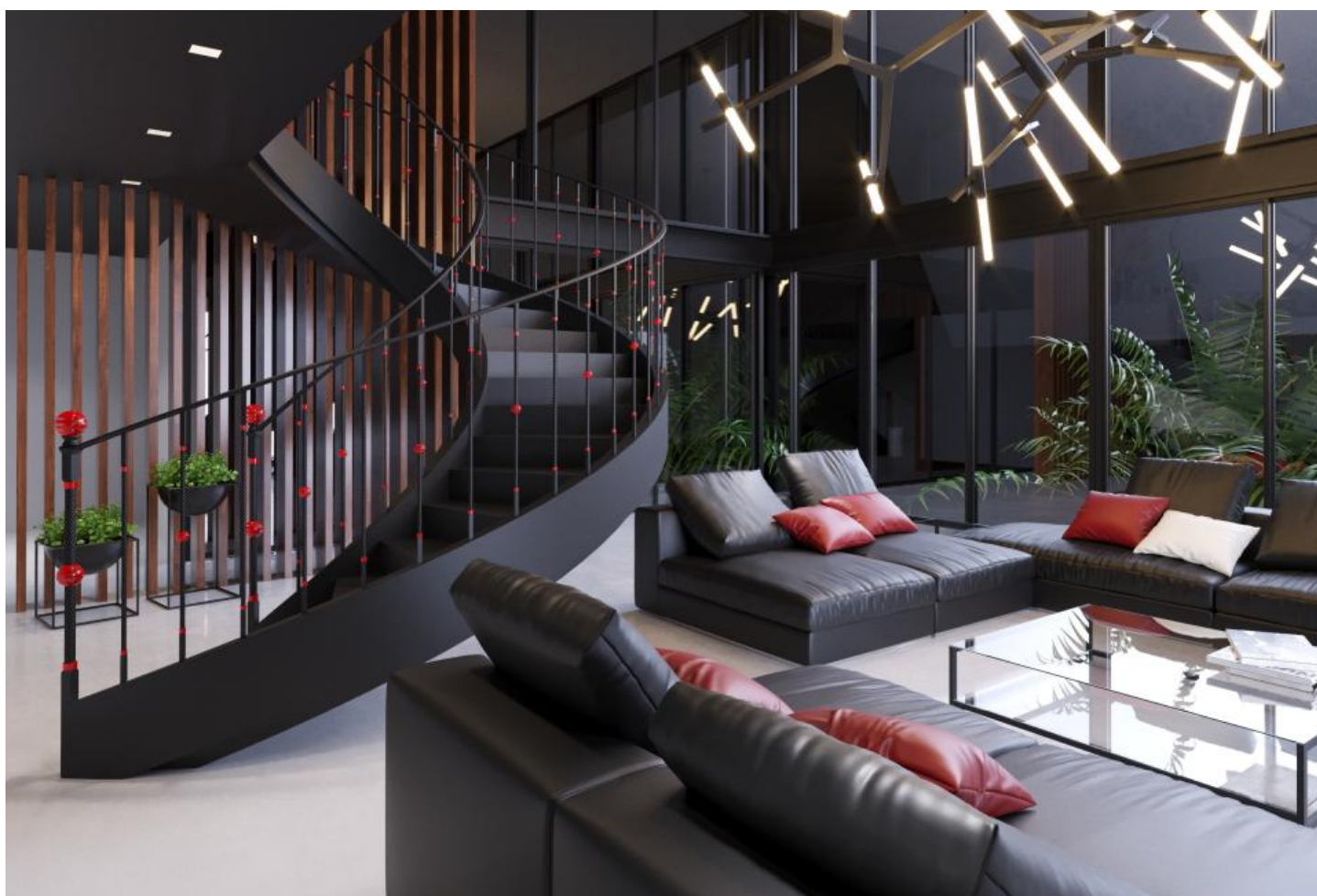

# CARBONE RED

ø 90mm  
H : 140mm

ø 3 1/2"  
H : 5 1/2"



TCARB-RED



TBL90-RED

ø 100mm  
H : 140mm

ø 4"  
H : 5 1/2"



TBL70-RED



● 16 mm 5/8"	Ø = 63mm Ø = 2 1/2"	CSR16-RED
● 40 mm 1 5/8"	Ø = 120mm Ø = 4 3/4"	CSR40-RED
● 42.4 mm 1 11/16"	Ø = 80mm Ø = 1 1/8"	CSR42-RED

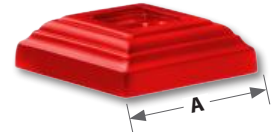

■ 16 mm 5/8"	A = 60mm A = 2 3/8"	CSK16-RED
■ 35 mm 1 3/8"	A = 92mm A = 3 5/8"	CSK35-RED



● 16 mm 5/8"	Ø = 63mm Ø = 2 1/2"	CSR16CARB
● 40 mm 1 5/8"	Ø = 120mm Ø = 4 3/4"	CSR40CARB
● 42.4 mm 1 11/16"	Ø = 80mm Ø = 3 1/8"	CSR42CARB

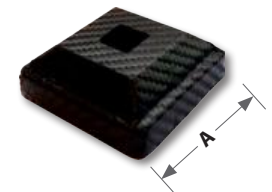

■ 16 mm 5/8"	A = 60mm A = 2 3/8"	CSK16CARB
■ 35 mm 1 3/8"	A = 92mm A = 3 5/8"	CSK35CARB

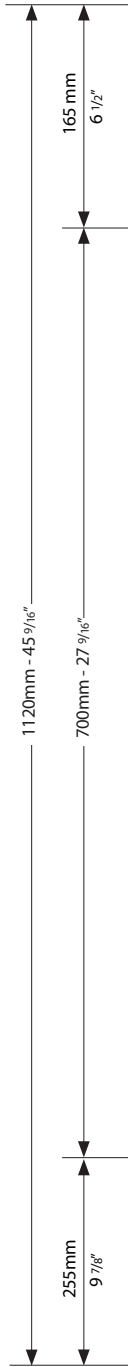
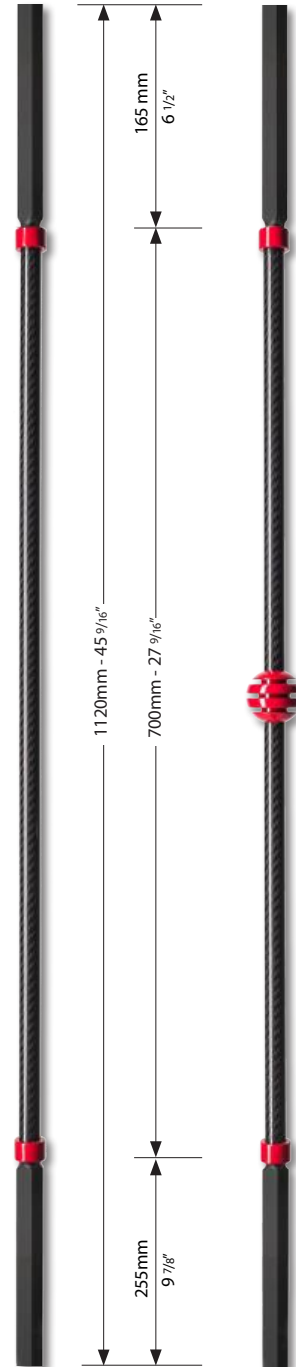
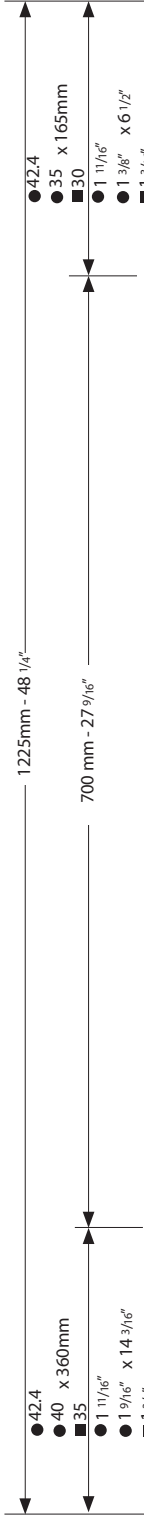
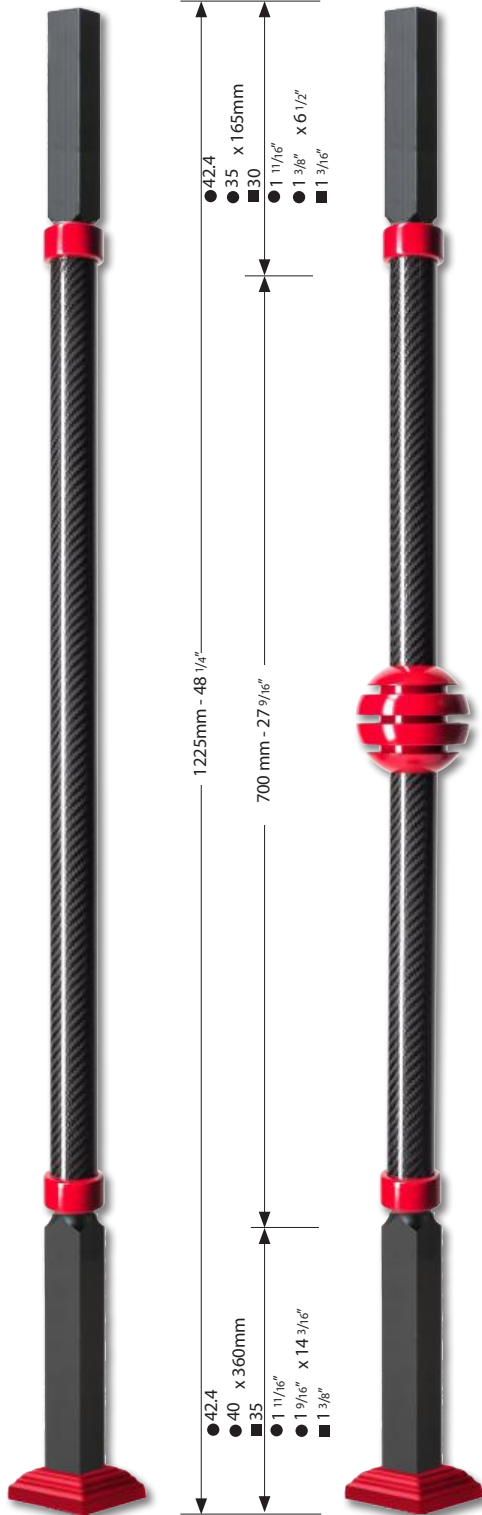

● 40 mm 1 5/8"	PCAR10-R-RED	PCAR11-R-RED
● 42.4 mm INOX 1 11/16"	PCAR10-W-RED	PCAR11-W-RED
■ 35 mm 1 3/8"	PCAR10-K-RED	PCAR11-K-RED

BCAR10-R-RED	BCAR11-R-RED	16 mm 5/8"	●
BCAR10-W-RED	BCAR11-W-RED	16 mm INOX 5/8"	●
BCAR10-K-RED	BCAR11-K-RED	16 mm 5/8"	■

FRANCE  
**gf**  
1948

CARBONE



# CARBONE BLUE

ø 90mm  
H: 140mm

ø 3 1/2"  
H: 5 1/2"

ø 100mm  
H: 140mm

ø 4"  
H: 5 1/2"



TCARB-BLU



TBL90-BLU



TBL70-BLU

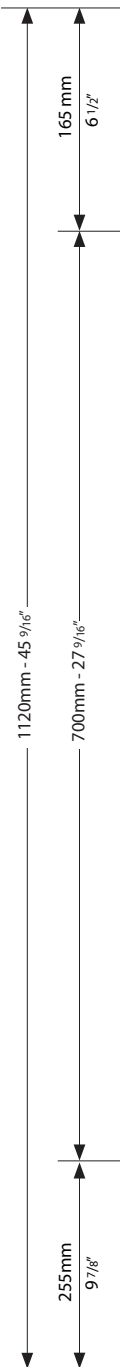
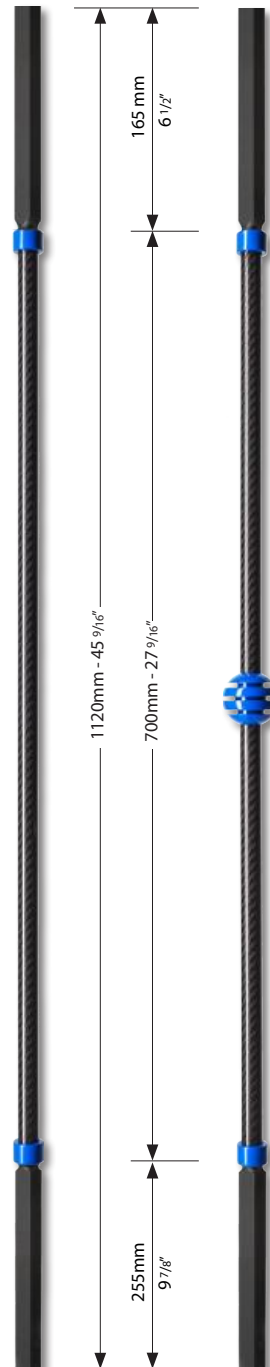
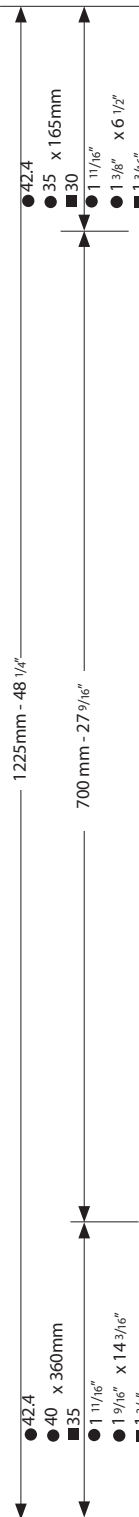
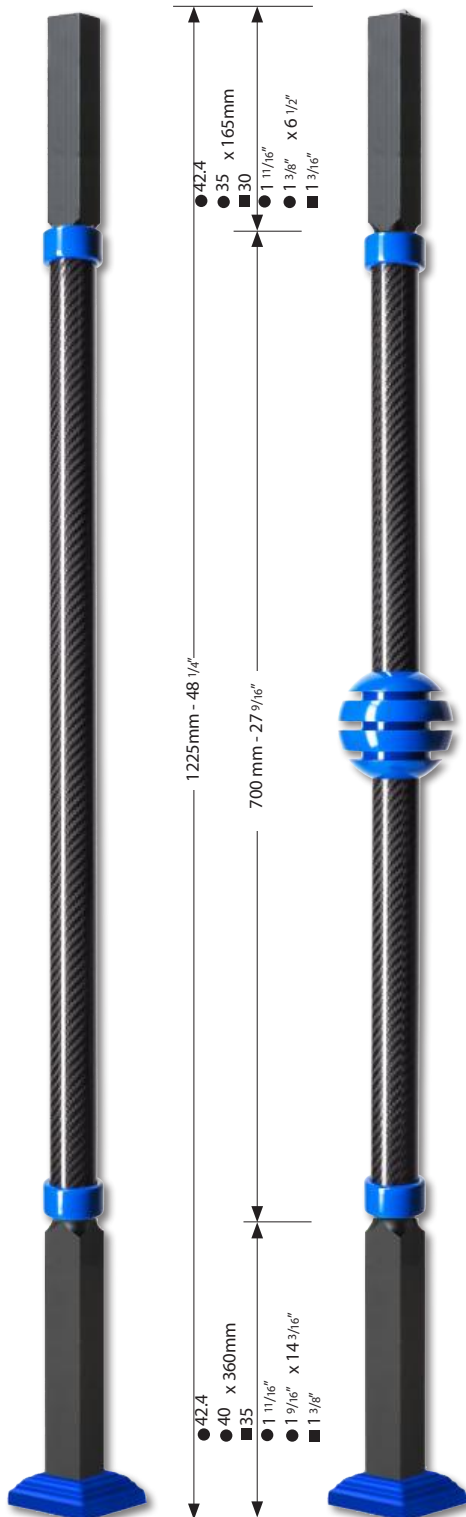

● 16 mm 5/8"	Ø = 63mm Ø = 2 1/2"	CSR16-BLU
● 40 mm 1 5/8"	Ø = 120mm Ø = 4 3/4"	CSR40-BLU
● 42.4 mm 1 11/16"	Ø = 80mm Ø = 3 1/8"	CSR42-BLU

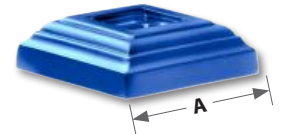

■ 16 mm 5/8"	A = 60mm A = 2 3/8"	CSK16-BLU
■ 35 mm 1 3/8"	A = 92mm A = 3 5/8"	CSK35-BLU



● 16 mm 5/8"	Ø = 63mm Ø = 2 1/2"	CSR16CARB
● 40 mm 1 5/8"	Ø = 120mm Ø = 4 3/4"	CSR40CARB
● 42.4 mm 1 11/16"	Ø = 80mm Ø = 3 1/8"	CSR42CARB

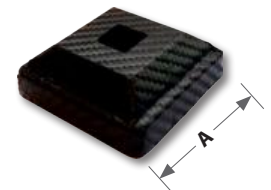

■ 16 mm 5/8"	A = 60mm A = 2 3/8"	CSK16CARB
■ 35 mm 1 3/8"	A = 92mm A = 3 5/8"	CSK35CARB

● 40 mm 1 5/8"	PCAR10-R-BLU	PCAR11-R-BLU
● 42.4 mm INOX 1 11/16"	PCAR10-W-BLU	PCAR11-W-BLU
■ 35 mm 1 3/8"	PCAR10-K-BLU	PCAR11-K-BLU

BCAR10-R-BLU	BCAR11-R-BLU	16 mm 5/8"	●
BCAR10-W-BLU	BCAR11-W-BLU	16 mm INOX 5/8"	●
BCAR10-K-BLU	BCAR11-K-BLU	16 mm 5/8"	■





# CARBONE WHITE

ø 90mm  
H: 140mm

ø 3 1/2"  
H: 5 1/2"

FRANCE  
**gf**  
1948



TCARB-WHI



TBL90-WHI

ø 100mm  
H: 140mm

ø 4"  
H: 5 1/2"



TBL70-WHI

ø 54mm  
ø 2 1/8"

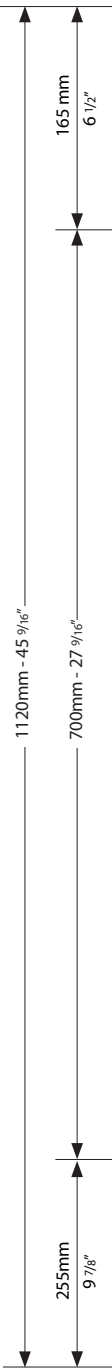
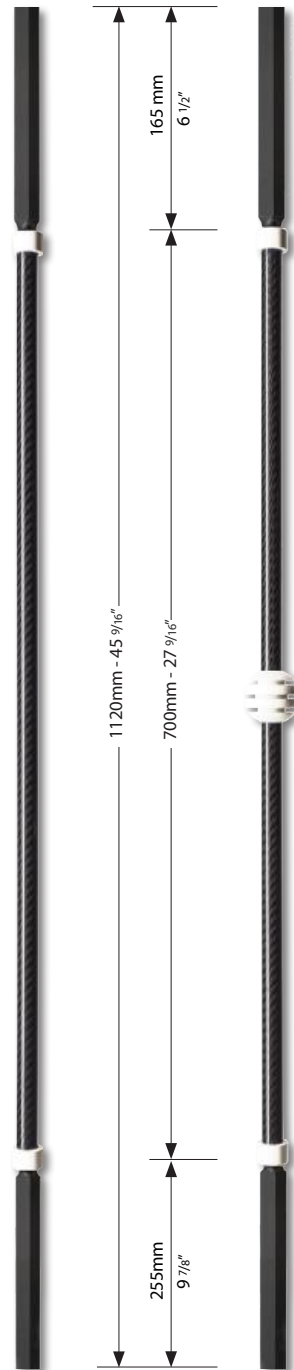
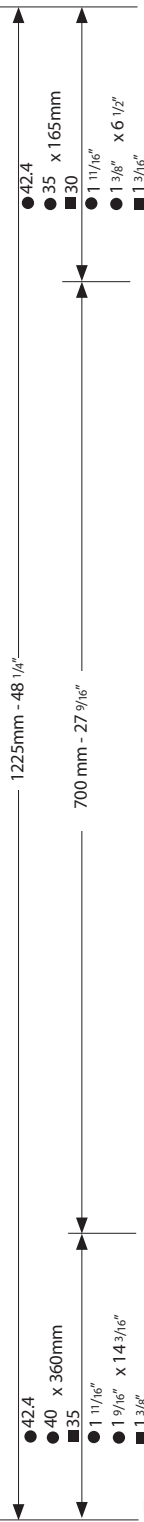
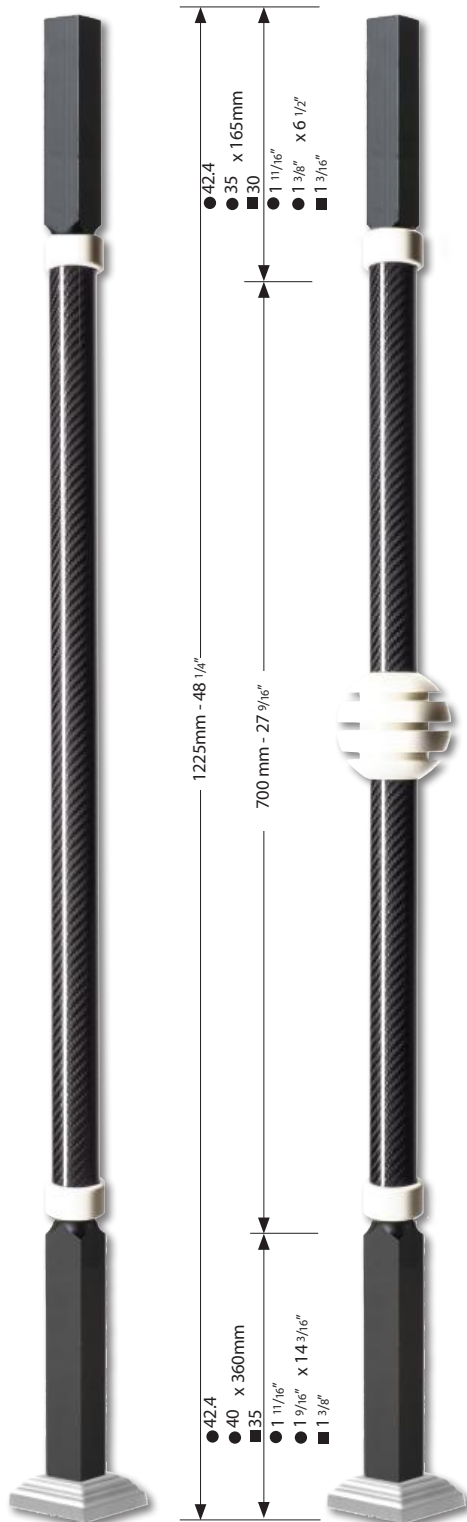

● 16 mm 5/8"	Ø = 63mm Ø = 2 1/2"	CSR16-WHI
● 40 mm 1 5/8"	Ø = 120mm Ø = 4 3/4"	CSR40-WHI
● 42.4 mm 1 11/16"	Ø = 80mm Ø = 3 1/8"	CSR42-WHI

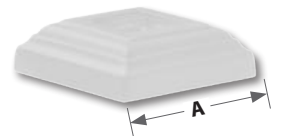

■ 16 mm 5/8"	A = 60mm A = 2 3/8"	CSK16-WHI
■ 35 mm 1 3/8"	A = 92mm A = 3 5/8"	CSK35-WHI



● 16 mm 5/8"	Ø = 63mm Ø = 2 1/2"	CSR16CARB
● 40 mm 1 5/8"	Ø = 120mm Ø = 4 3/4"	CSR40CARB
● 42.4 mm 1 11/16"	Ø = 80mm Ø = 3 1/8"	CSR42CARB

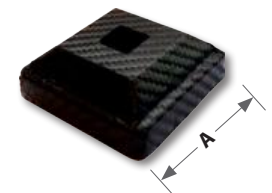

■ 16 mm 5/8"	A = 60mm A = 2 3/8"	CSK16CARB
■ 35 mm 1 3/8"	A = 92mm A = 3 5/8"	CSK35CARB

CARBONE

● 40 mm 1 5/8"	PCAR10-R-WHI	PCAR11-R-WHI
● 42.4 mm INOX 1 11/16"	PCAR10-W-WHI	PCAR11-W-WHI
■ 35 mm 1 3/8"	PCAR10-K-WHI	PCAR11-K-WHI

BCAR10-R-WHI	BCAR11-R-WHI	16 mm ●
BCAR10-W-WHI	BCAR11-W-WHI	16 mm INOX ●
BCAR10-K-WHI	BCAR11-K-WHI	16 mm ■



# CARBONE

## Black Chrome

ø 90mm  
H : 140mm

ø 3 1/2"  
H : 5 1/2"

ø 100mm  
H : 140mm

ø 4"  
H : 5 1/2"

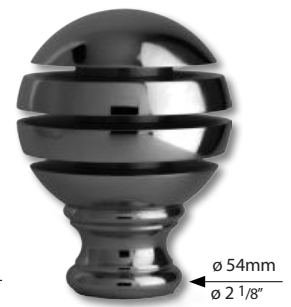

TCARB-CN

TBL70CN

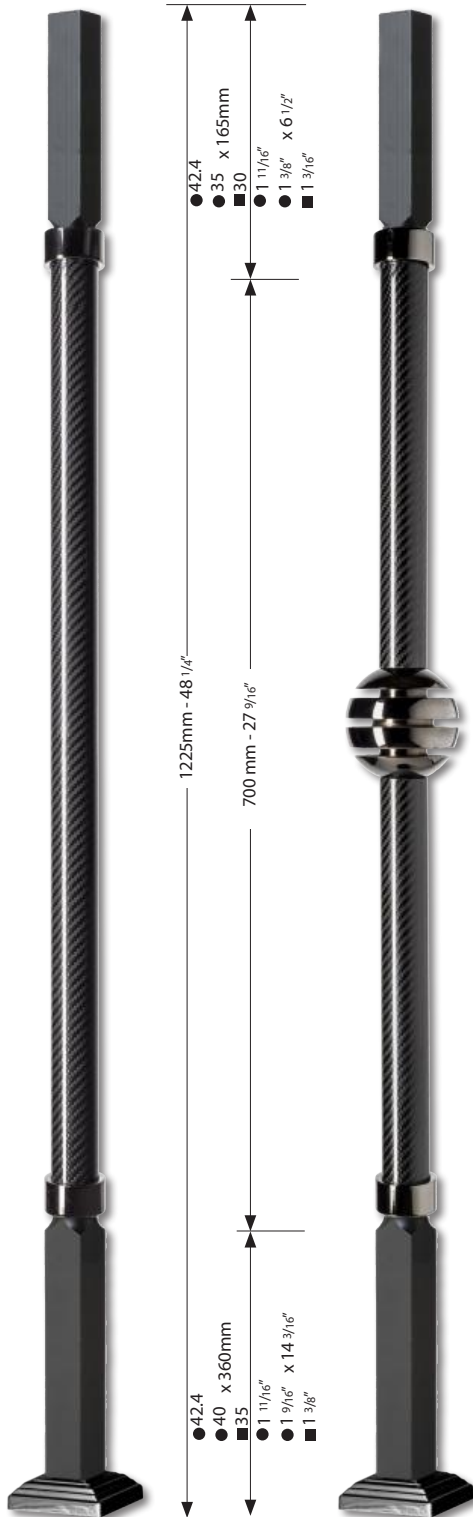

● 42.4  
● 35 x 165mm  
■ 30  
● 1 11/16"  
● 1 3/8" x 6 1/2"  
■ 1 3/16"

1225mm - 48 1/4"  
700mm - 27 9/16"

● 42.4  
● 40 x 360mm  
■ 35  
● 1 11/16"  
● 1 9/16" x 14 3/16"  
■ 1 3/8"

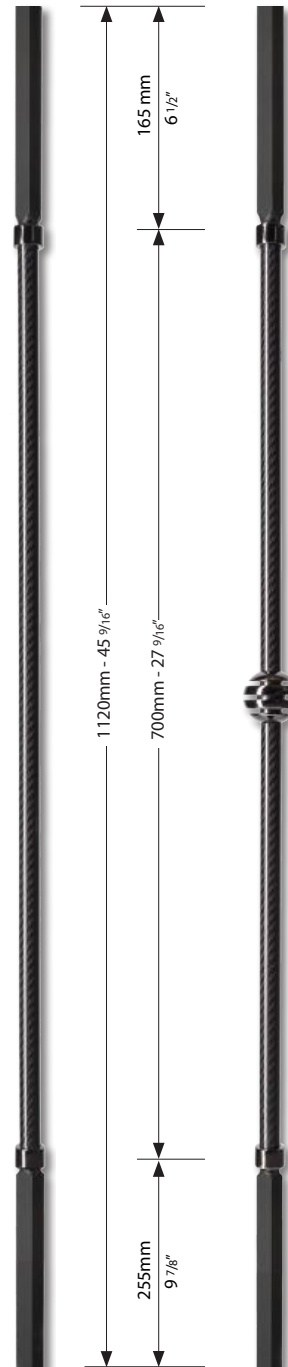

165mm  
6 1/2"  
1120mm - 45 9/16"  
700mm - 27 9/16"

255mm  
9 7/8"



● 16 mm 5/8"	Ø = 63mm Ø = 2 1/2"	CSL61CN
● 40 mm 1 5/8"	Ø = 120mm Ø = 4 3/4"	CSL114CN
● 42.4 mm 1 11/16"	Ø = 80mm Ø = 3 1/8"	CSR42CN

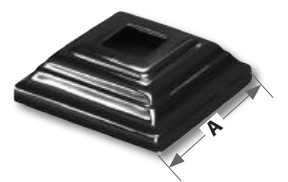

■ 16 mm 5/8"	A = 60mm A = 2 3/8"	CSL616CN
■ 35 mm 1 3/8"	A = 85mm A = 3 3/8"	CSL835CN



● 16 mm 5/8"	Ø = 63mm Ø = 2 1/2"	CSR16CARB
● 40 mm 1 5/8"	Ø = 120mm Ø = 4 3/4"	CSR40CARB
● 42.4 mm 1 11/16"	Ø = 80mm Ø = 3 1/8"	CSR42CARB

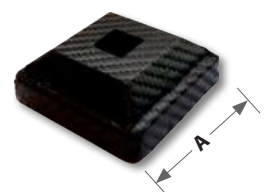

■ 16 mm 5/8"	A = 60mm A = 2 3/8"	CSK16CARB
■ 35 mm 1 3/8"	A = 92mm A = 3 5/8"	CSK35CARB

● 40 mm 1 5/8"	PCAR10-R-CN	PCAR11-R-CN
● 42.4 mm INOX 1 11/16"	PCAR10-W-CN	PCAR11-W-CN
■ 35 mm 1 3/8"	PCAR10-K-CN	PCAR11-K-CN

BCAR10-R-CN	BCAR11-R-CN	16 mm ●
BCAR10-W-CN	BCAR11-W-CN	16 mm INOX ●
BCAR10-K-CN	BCAR11-K-CN	16 mm 5/8" ■



**FRANÇAIS :** Départs de rampe "LATERAL", en acier moulé recouvert d'un film carbone.  
Livrés avec une sous-lisse en fer plat de 20/12 mm.

**ENGLISH :** "LATERAL" rail ends, made of cast steel with carbon cover.  
Supplied with a 20/12 mm (3/4" x 1/2") steel scroll.

**FRANÇAIS :** Support - cavalier de main courante en fer brut à souder à la sous-lisse. Produits conçus exclusivement pour l'intérieur.

**ENGLISH :** Handrail brackets made of steel, to weld on. Items for indoor use only.

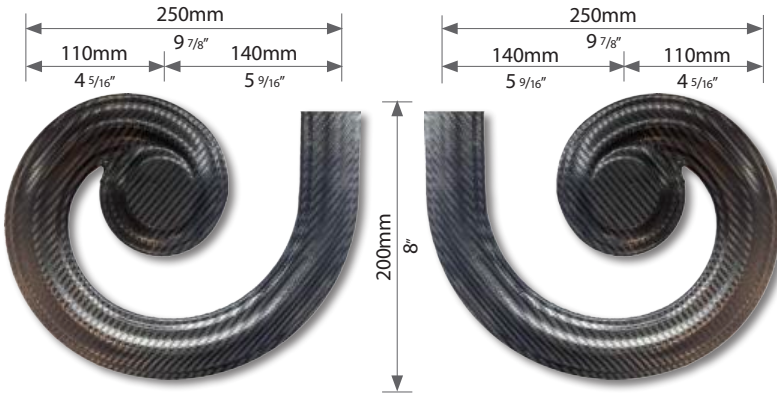

**DR 245 LCARB**

**DR 245 RCARB**

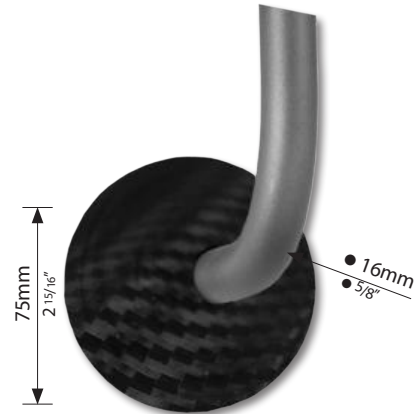

**SML 31 CARB**

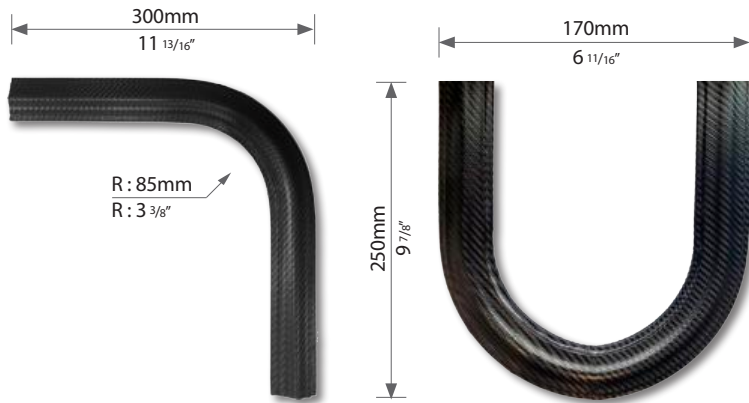

**CO-CARB**

**CU-CARB**

**FRANÇAIS :** Film adhésif à effet texturé 3D Carbone pour recouvrir les mains courantes. Largeur 120 mm

**ENGLISH :** Carbon 3D textured adhesive film for covering handrails. Width 120 mm



**FILM-CARBONE**

**Vendu au mètre. A spécifier lors de la commande.**  
**Sold by the meter. To be specified when ordering.**  
**Продается по метру. Указать при заказе**

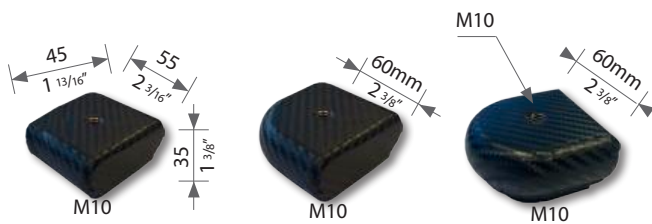

M10

M10

M10

**TS6CARB**

**TS5CARB**

**TS4CARB**

Embase passante  
Passing base

Embase d'angle  
Base for angle

Embase d'extrémité  
Extremity base

**FRANÇAIS :** Bague couvre-joint en acier moulé recouvert d'un film carbone.

**ENGLISH :** Steel castings coverjoint collar with carbon cover.



**RA 40 CARB**

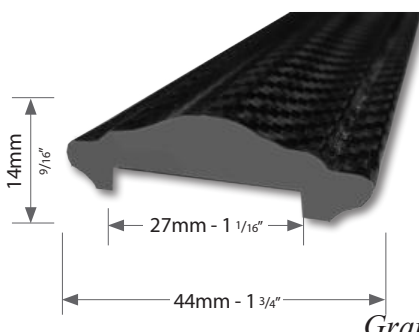

**FRANÇAIS :** Main courante en fer mouluré recouvert d'un film carbone. Livrée en longueur de 3 mètres.

**ENGLISH :** Formed steel handrail with carbon cover. Supplied in 3 meter (ca. 10 ft.) lengths.

**MC-CARB**

**FRANÇAIS :** Départ en acier recouvert d'un film carbone, prévu pour sous-lisse en plat de 20 x 12 mm.

**ENGLISH :** Rail ends, made of cast steel with carbon cover. Supplied with a 20/12 mm (3/4" x 1/2") steel scroll.



**DRC 305 CARB**

***G=Gold NI=Nickel SA=Satin***

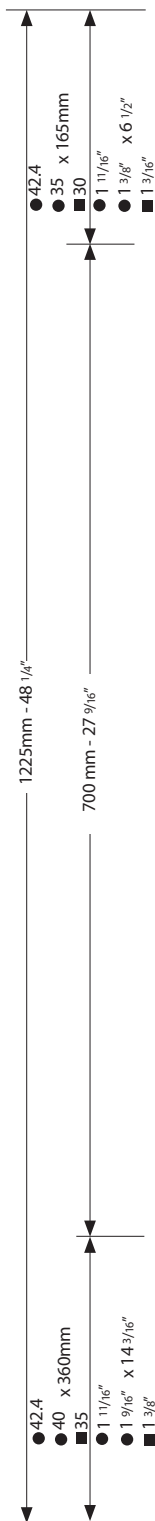

● 40 mm 1 5/8"	PCAR10-R-G	PCAR11-R-G	PCAR10-R-NI	PCAR11-R-NI	PCAR10-R-SA	PCAR11-R-SA
● 42.4 mm INOX 1 11/16"	PCAR10-W-G	PCAR11-W-G	PCAR10-W-NI	PCAR11-W-NI	PCAR10-W-SA	PCAR11-W-SA
■ 35 mm 1 3/8"	PCAR10-K-G	PCAR11-K-G	PCAR10-K-NI	PCAR11-K-NI	PCAR10-K-SA	PCAR11-K-SA





ø 90mm  
H: 140mm

ø 3 1/2"  
H: 5 1/2"

ø 100mm  
H: 140mm

ø 4"  
H: 5 1/2"

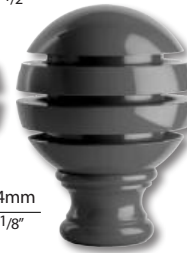

ø 54mm  
ø 2 1/8"

ø 54mm  
ø 2 1/8"

**TCARB-G**

**TCARB-NI**

**TCARB-SA**

**TBL70G**

**TBL70NI**

**TBL70SA**



- 16 mm Ø = 63mm 5/8" Ø = 2 1/2" **CSL61G**
- 40 mm Ø = 110mm 1 5/8" Ø = 4 5/16" **CSL114G**
- 42.4 mm Ø = 80mm 1 11/16" Ø = 3 1/8" **CSR42-G**



- 16 mm Ø = 63mm 5/8" Ø = 2 1/2" **CSL61NI**
- 40 mm Ø = 110mm 1 5/8" Ø = 4 5/16" **CSL114NI**
- 42.4 mm Ø = 80mm 1 11/16" Ø = 3 1/8" **CSR42-NI**

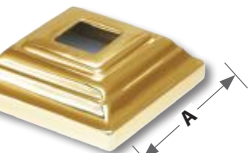

- 16 mm A = 60mm 5/8" A = 2 3/8" **CSL61SA**
- 40 mm A = 110mm 1 5/8" A = 4 5/16" **CSL114SA**
- 42.4 mm A = 80mm 1 11/16" A = 3 1/8" **CSR42-SA**

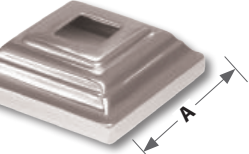

- 16 mm A = 60mm 5/8" A = 2 3/8" **CSL616G**
- 35 mm A = 85mm 1 3/8" A = 3 3/8" **CSL835G**

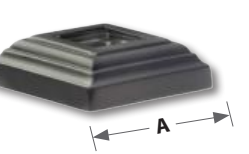

- 16 mm A = 60mm 5/8" A = 2 3/8" **CSL616NI**
- 35 mm A = 85mm 1 3/8" A = 3 3/8" **CSL835NI**



- 16 mm A = 60mm 5/8" A = 2 3/8" **CSL616SA**
- 35 mm A = 85mm 1 3/8" A = 3 3/8" **CSL835SA**



CARBONE

- 16 mm 5/8" **BCAR10-R-G BCAR11-R-G BCAR10-R-NI BCAR11-R-NI BCAR10-R-SA BCAR11-R-SA**
- 16 mm INOX 5/8" **BCAR10-W-G BCAR11-W-G BCAR10-W-NI BCAR11-W-NI BCAR10-W-SA BCAR11-W-SA**
- 16 mm 5/8" **BCAR10-K-G BCAR11-K-G BCAR10-K-NI BCAR11-K-NI BCAR10-K-SA BCAR11-K-SA**



# CARBONE

## Custom Color

**FRANÇAIS :** Les éléments de couleur jaune peuvent être peints selon la couleur de votre choix. Couleur RAL à spécifier lors de la commande.

**ENGLISH:** The yellow elements can be painted according to the color of your choice. RAL color to specify when ordering.

**RUSSE :** Желтые элементы могут быть окрашены в соответствии с цветом по вашему выбору. Цвет RAL указывать при оформлении заказа.

ø 100mm  
H: 140mm

ø 4"  
H: 5 1/2"



TCARB-SPE



TBL90-SPE



TBL70-SPE

ø 54mm  
ø 2 1/8"

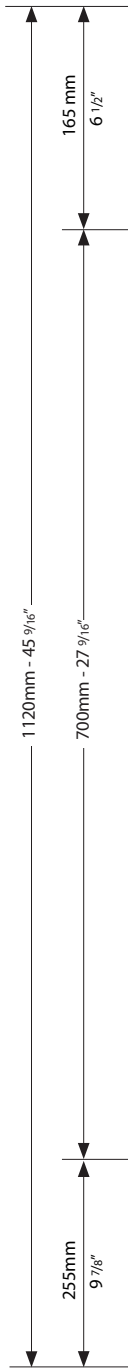
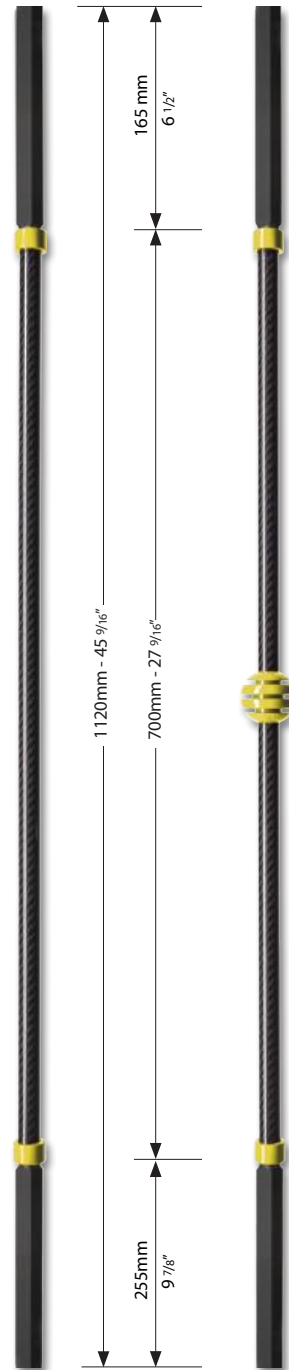
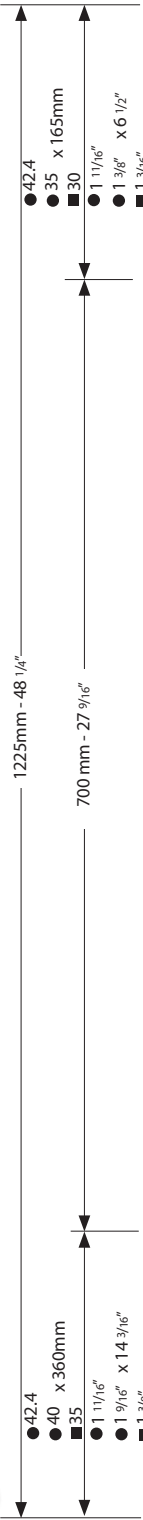
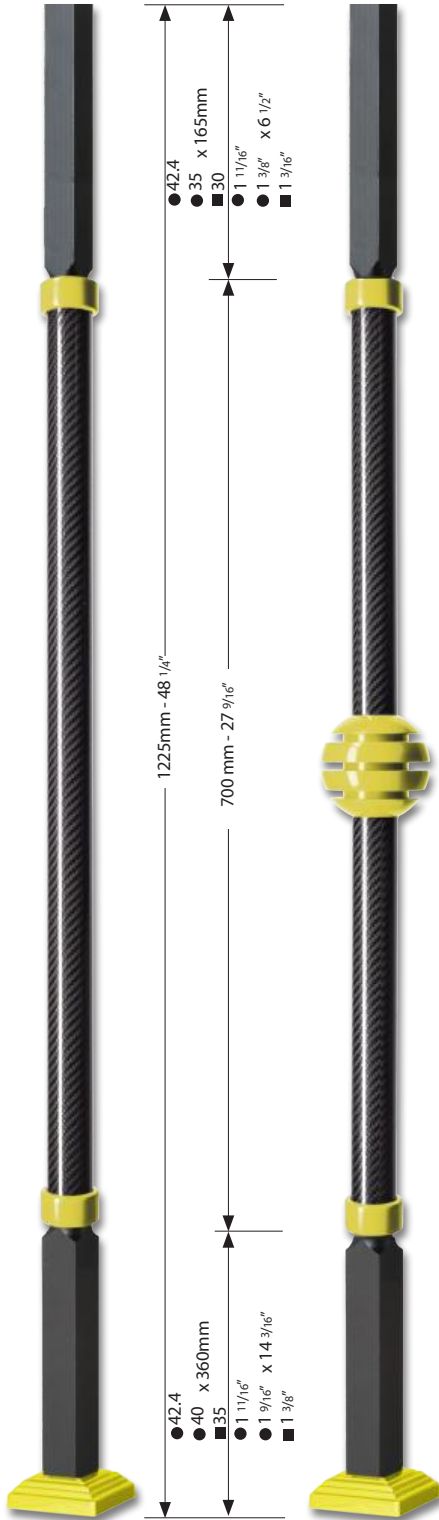

● 16 mm 5/8"	Ø = 63mm Ø = 2 1/2"	<b>CSR16-SPE</b>
● 40 mm 1 5/8"	Ø = 120mm Ø = 4 3/4"	<b>CSR40-SPE</b>
● 42.4 mm 1 11/16"	Ø = 80mm Ø = 3 1/8"	<b>CSR42-SPE</b>

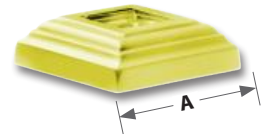

■ 16 mm 5/8"	A = 60mm A = 2 3/8"	<b>CSK16-SPE</b>
■ 35 mm 1 3/8"	A = 85mm A = 3 3/8"	<b>CSK35-SPE</b>



● 16 mm 5/8"	Ø = 63mm Ø = 2 1/2"	<b>CSR16CARB</b>
● 40 mm 1 5/8"	Ø = 120mm Ø = 4 3/4"	<b>CSR40CARB</b>
● 42.4 mm 1 11/16"	Ø = 80mm Ø = 3 1/8"	<b>CSR42CARB</b>

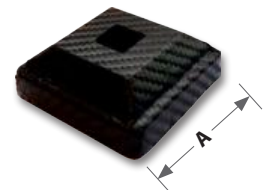

■ 16 mm 5/8"	A = 60mm A = 2 3/8"	<b>CSK16CARB</b>
■ 35 mm 1 3/8"	A = 92mm A = 3 5/8"	<b>CSK35CARB</b>

● 40 mm 1 5/8"	<b>PCAR10-R-SPE</b>	<b>PCAR11-R-SPE</b>
● 42.4mm INOX 1 11/16"	<b>PCAR10-W-SPE</b>	<b>PCAR11-W-SPE</b>
■ 35 mm 1 3/8"	<b>PCAR10-K-SPE</b>	<b>PCAR11-K-SPE</b>

<b>BCAR10-R-SPE</b>	<b>BCAR11-R-SPE</b>	16 mm ●
<b>BCAR10-W-SPE</b>	<b>BCAR11-W-SPE</b>	16 mm INOX ●
<b>BCAR10-K-SPE</b>	<b>BCAR11-K-SPE</b>	16 mm ■



**MAINS COURANTES PRÊTES A POSER**  
**READY TO INSTALL HANDRAIL**  
**EINBAUFERTIGER HANDLAUF**  
**LEUNINGEN KLAAR OM OP TE HANGEN**  
**BARANDILLA LISTA PARA INSTALAR**  
**ГОТОВЫЕ К УСТАНОВКЕ ПОРУЧНИ**

CARBONE

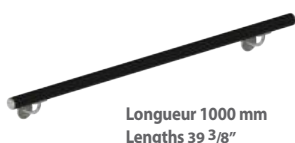
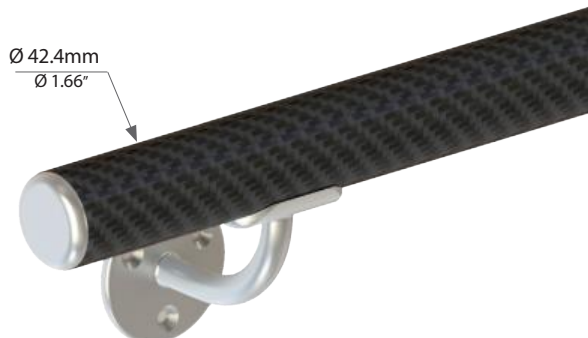
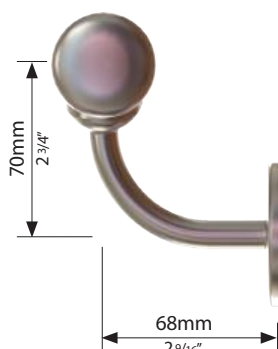
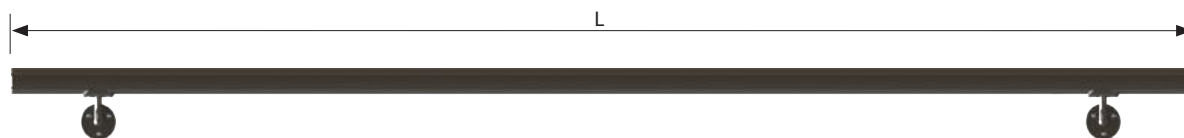

Longueur 1000 mm  
Lengths 39 3/8"

MC-C91-1000



Longueur 1500 mm  
Lengths 58 5/8"

MC-C91-1500



Longueur 2000 mm  
Lengths 78"

MC-C91-2000

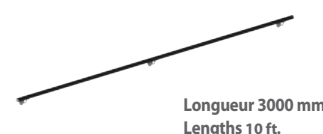

Longueur 3000 mm  
Lengths 10 ft.

MC-C91-3000

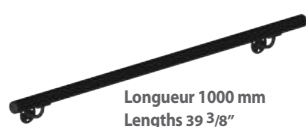
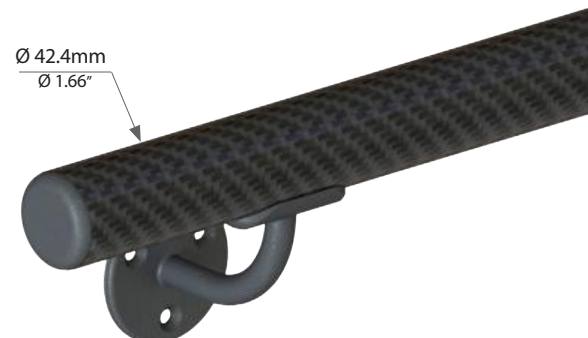
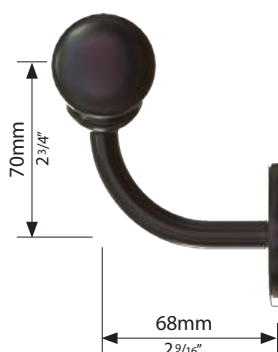

Longueur 1000 mm  
Lengths 39 3/8"

MC-CB1-1000

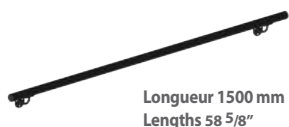

Longueur 1500 mm  
Lengths 58 5/8"

MC-CB1-1500



Longueur 2000 mm  
Lengths 78"

MC-CB1-2000

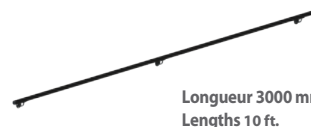

Longueur 3000 mm  
Lengths 10 ft.

MC-CB1-3000

# CARBONE

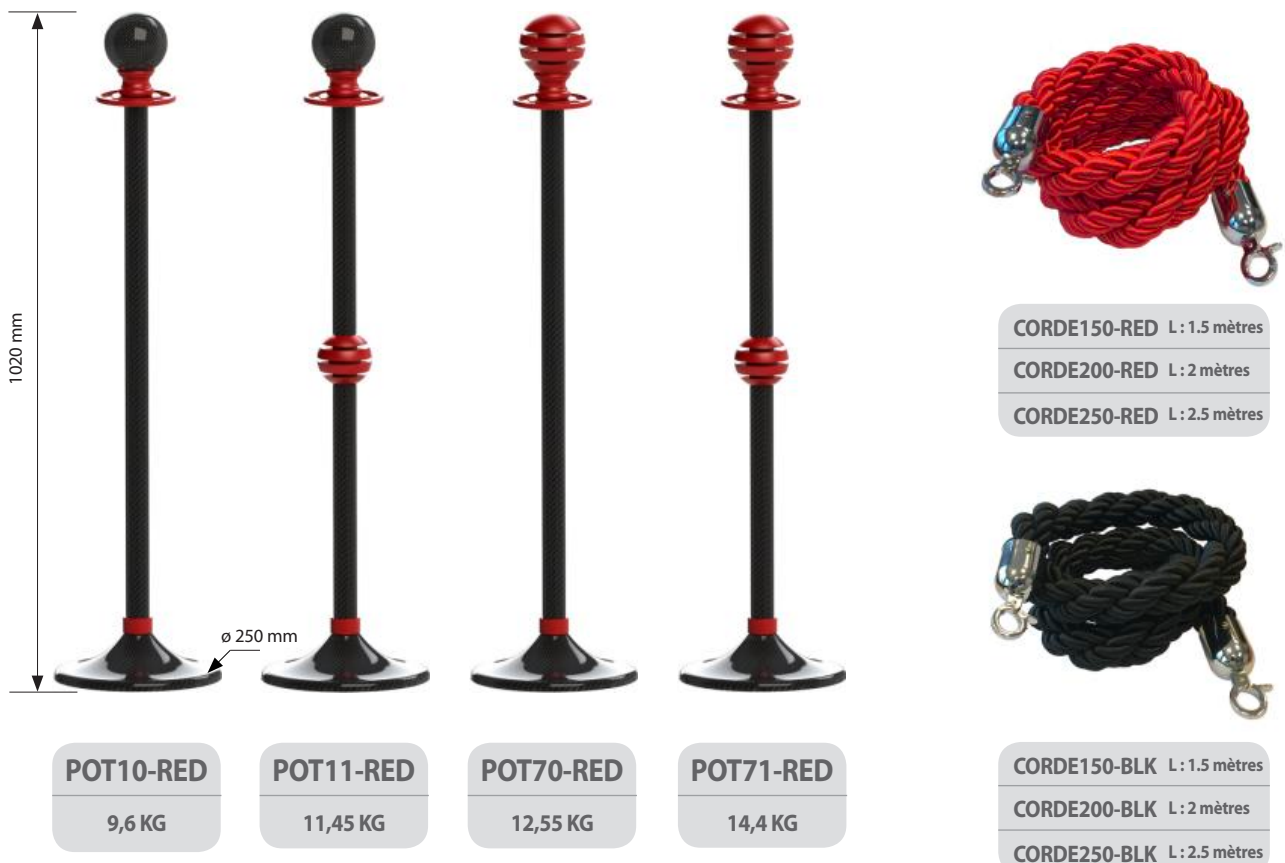





CARBONE



**POT10-W**  
9,6 KG

**POT11-W**  
11,45 KG

**POT70-W**  
12,55 KG

**POT71-W**  
14,4 KG



**CORDE150-RED** L: 1.5 mètres

**CORDE200-RED** L: 2 mètres

**CORDE250-RED** L: 2.5 mètres



**CORDE150-BLK** L: 1.5 mètres

**CORDE200-BLK** L: 2 mètres

**CORDE250-BLK** L: 2.5 mètres