

# CITY

**FRANÇAIS :** La série CITY allie une ligne moderne à un vrai travail de ferronnerie d'art. Conforme à la norme NF P01-012. Barreaux pour rampes d'escalier (A=770 mm) et pour garde-corps droits (A=820mm).

**DEUTSCH :** Die Reihe City verbindet eine moderne Linie mit einer wahren Schmiedekunst. Stäbe für Treppengeländer (A=770 mm) und für gerade Schutzgeländer (A=820 mm).

**ENGLISH :** The series City combines modern lines with authentic wrought iron work. All styles conform to requirements laid out in NF P01-012. Balusters for stairway handrail (A=770mm) and for level handrail (A=820mm).

**NEDERLANDS :** De serie City combineert een moderne lijn met authentiek siersmeedwerk. Alle stijlen voldoen aan de regelgeving NF P01-012. Spijlen voor trapleuningen (A=770 mm) en voor rechte leuningen en balustraden (A=820 mm).

**ESPAÑOL :** La serie City una línea moderna a un verdadero trabajo de cerrajería artística. Conforme a la norma NF P01-012. Balaustres para barandilla de escalera (A=770 mm) y para antepechos rectos (A=820 mm).

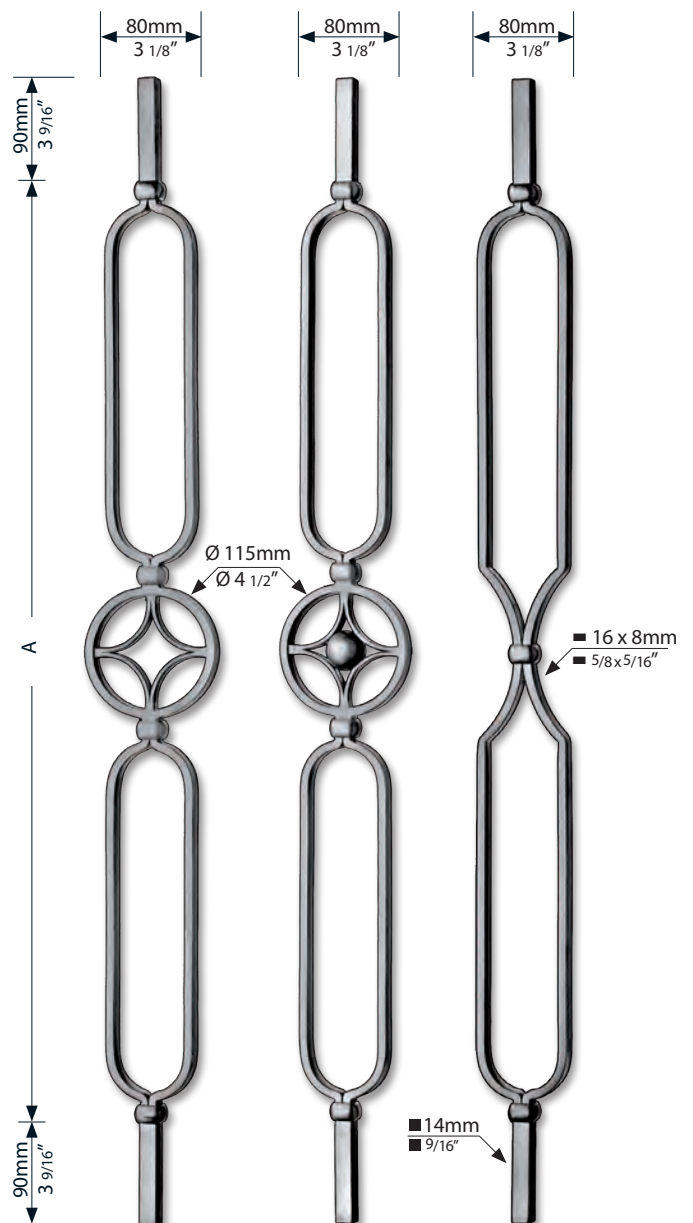
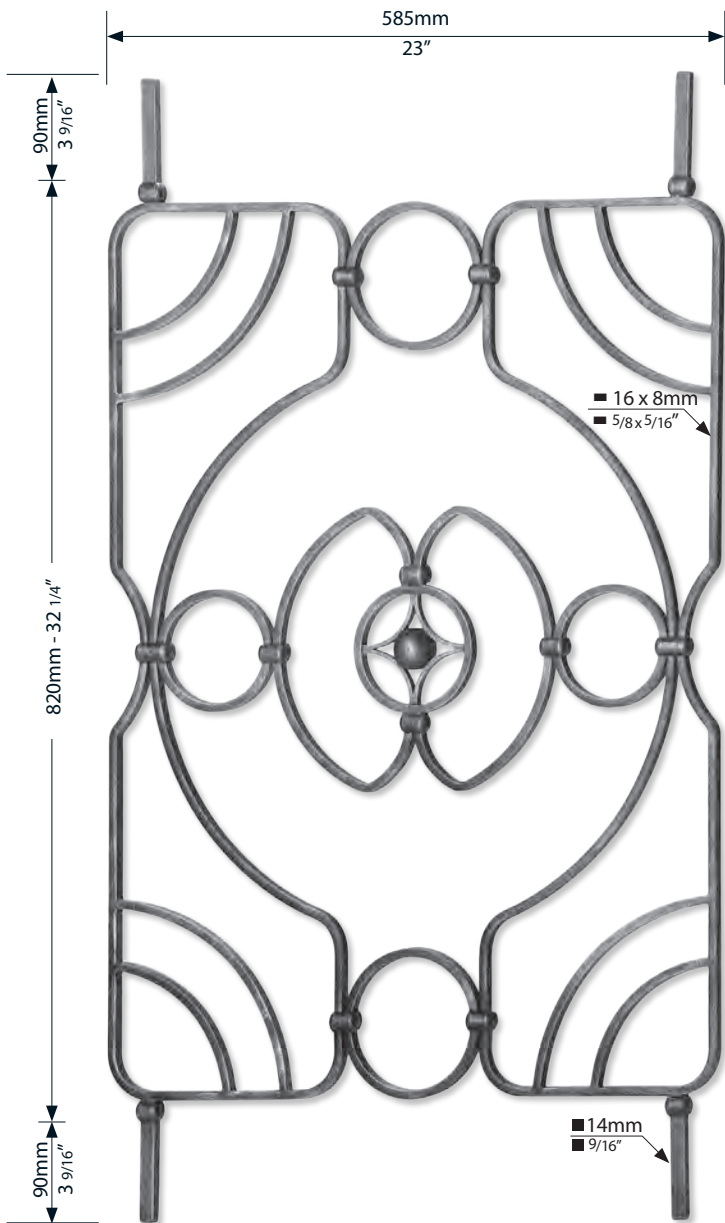

A = 770 mm A = 30 15/16"	CYB 110	CYB 120	CYB 130
A = 820 mm A = 32 1/4"	CYB 111	CYB 121	CYB 131

CYEL 125

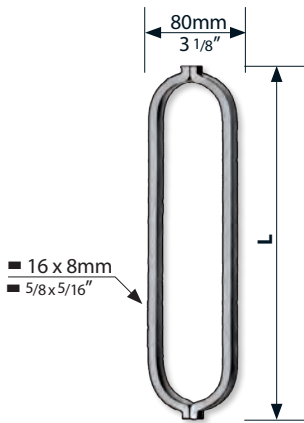

L = 315 mm  
 L = 123 3/8" **CYD 112**  
 L = 340 mm  
 L = 13 3/8" **CYD 113**

Cache-scellements en fer forgé à chaud.  
 Warm geschmiedete Abdeckrosetten.  
 Hot forged steel base collars.  
 Warm gesmede afdekrosetten.  
 Pletinas y embellecedores de hierro forjado en caliente.

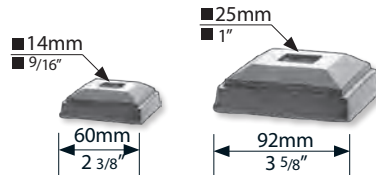

**CS 50**      **CS 80**

Eléments décoratifs en acier moulé. Soudables et galvanisables.  
 Zierelemente aus Schmiedeguß. Schweißbar und feuerverzinkbar.  
 Steel castings suitable for welding and galvanizing.  
 Geprofileerde sierornamenten uit las- en verzinkbaar gietijzer.  
 Elementos decorativos en acero moldeado. Soldables y galvanizables.

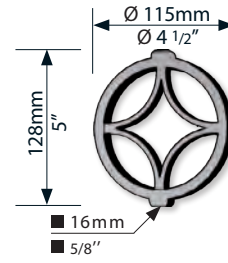

**CR 116**

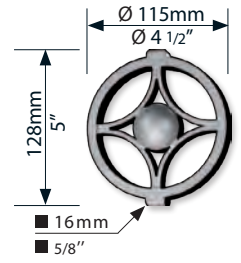

**CR 115**

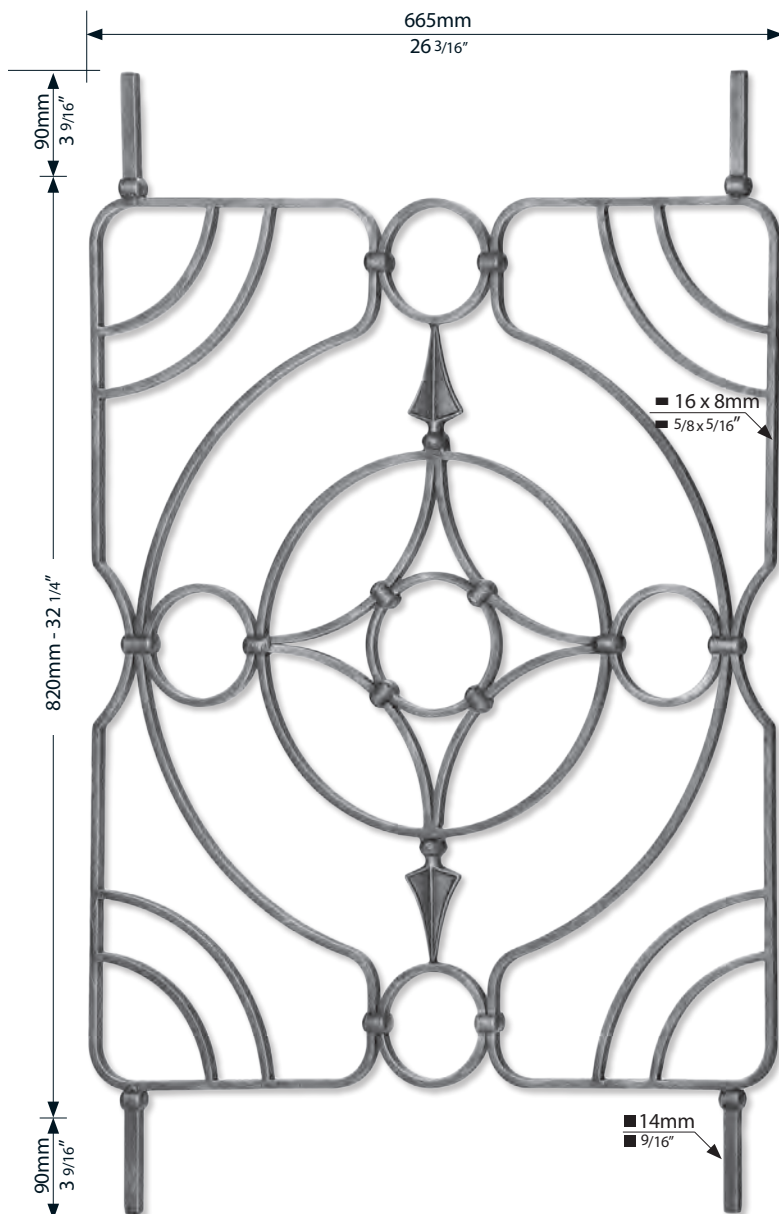

**CYEL 135**



Exemple d'utilisation - Anwendungsbeispiel  
 Illustration - Voorbeelden voor toepassingen  
 Ejemplo de empleo

Manchons en acier (galvanisables) avec vis de fixation.  
 Zierhülsen aus Eisen (Feuerverzinkbar) mit Blockierschraube.  
 Steel collars (suitable for galvanizing) are supplied with a set screw.  
 Sierhulzen uit staal voorzien (verzinkbaar) van een blokkeerschroef.  
 Macollas en acero (galvanizable) con tornillo de fijación.

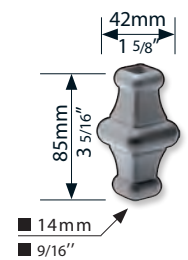

**EGK 82**



**EGK 125**